

MAUDY BK

10032025

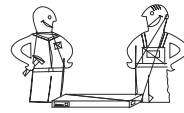

60 min



HDPE





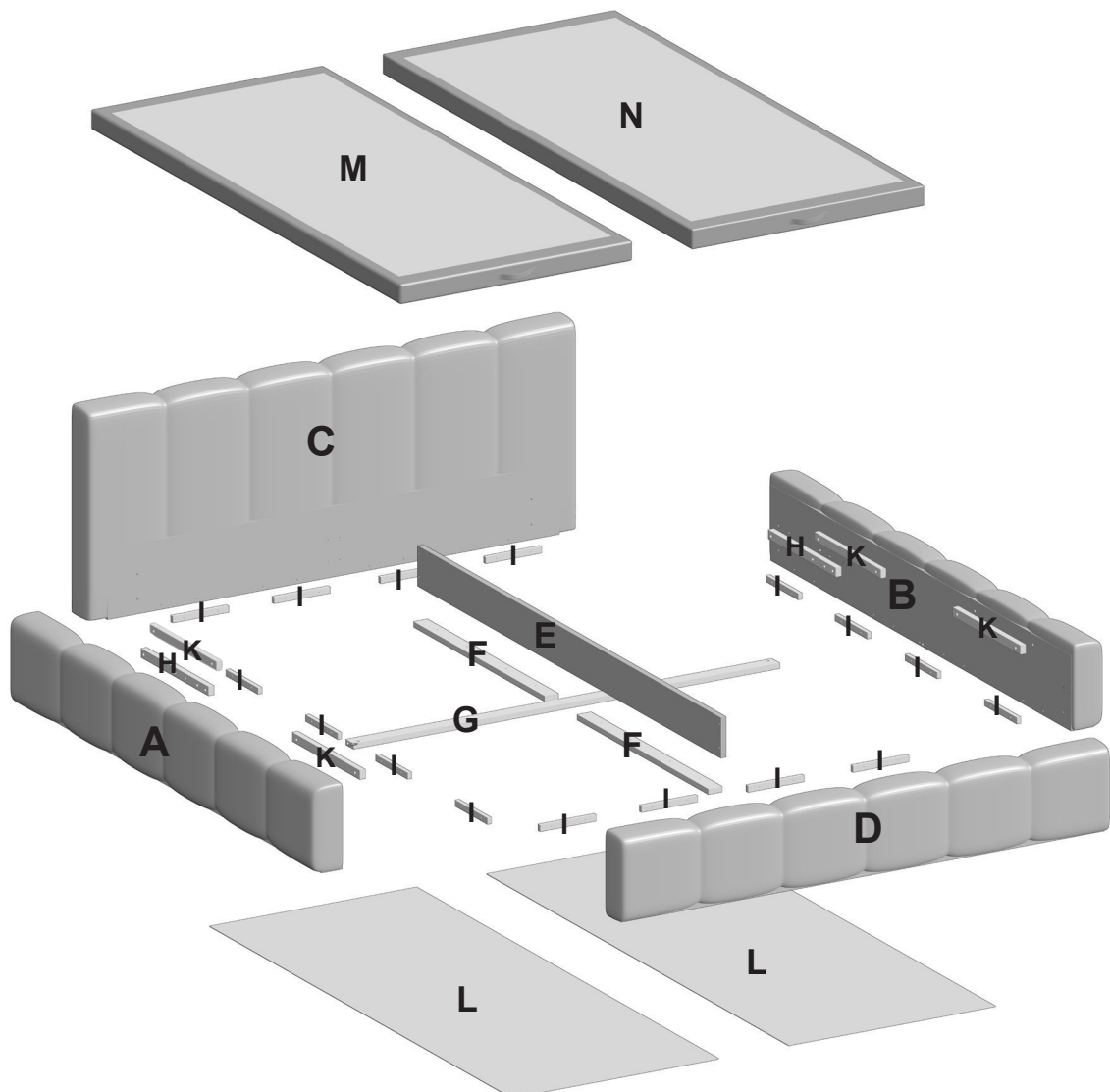
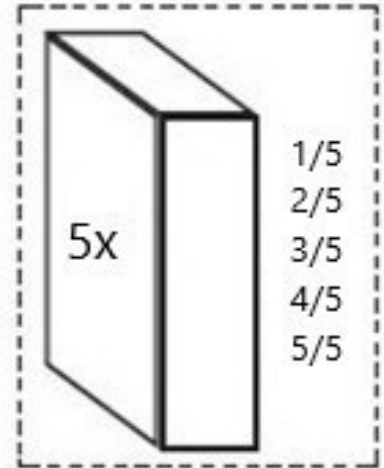
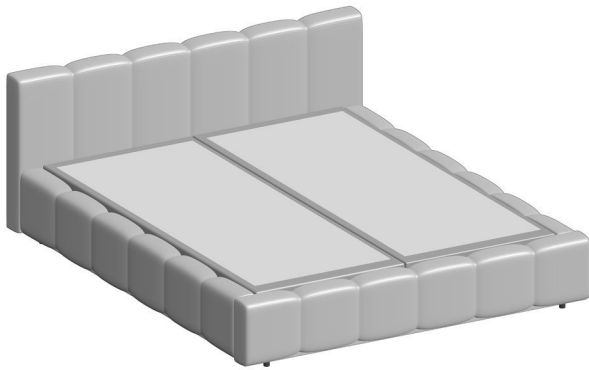



LDPE

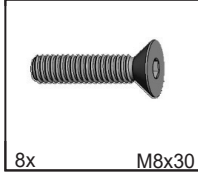

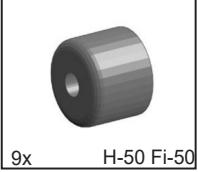
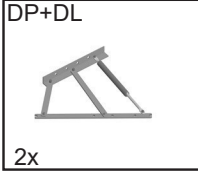
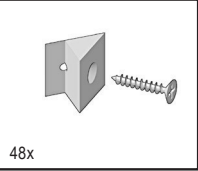
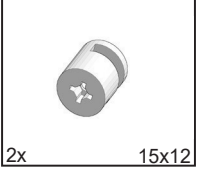
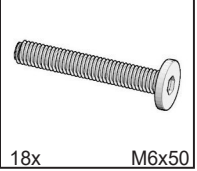
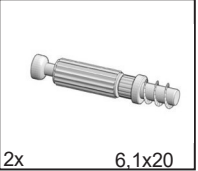
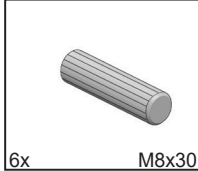
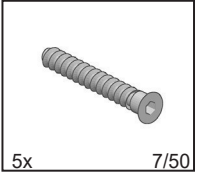
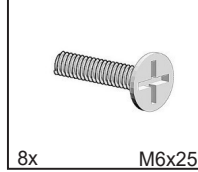
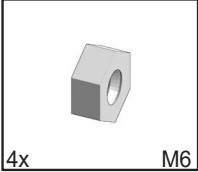
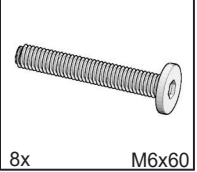
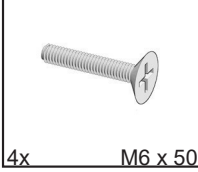
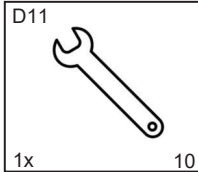
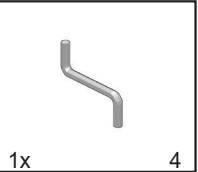
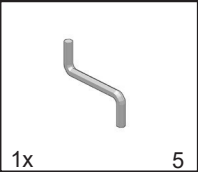
MAUDY BK

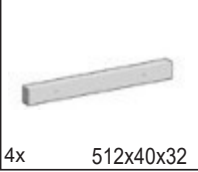
10032025

 4x	 8x M8x30	 8x M8x20	 2x	 9x H-50 Fi-50	 2x DP+DL
 48x	 41x 5x50	 2x 15x12	 18x M6x50	 2x 6.1x20	 6x M8x30
 5x 7/50	 8x M6x25	 4x M6	 8x M6x60	 4x M6 x 50	 1x D11 10
 1x 4	 1x 5	 16x 200x25x22	 2x 530x40x32	 4x 512x40x32	 2x
 4x					

1

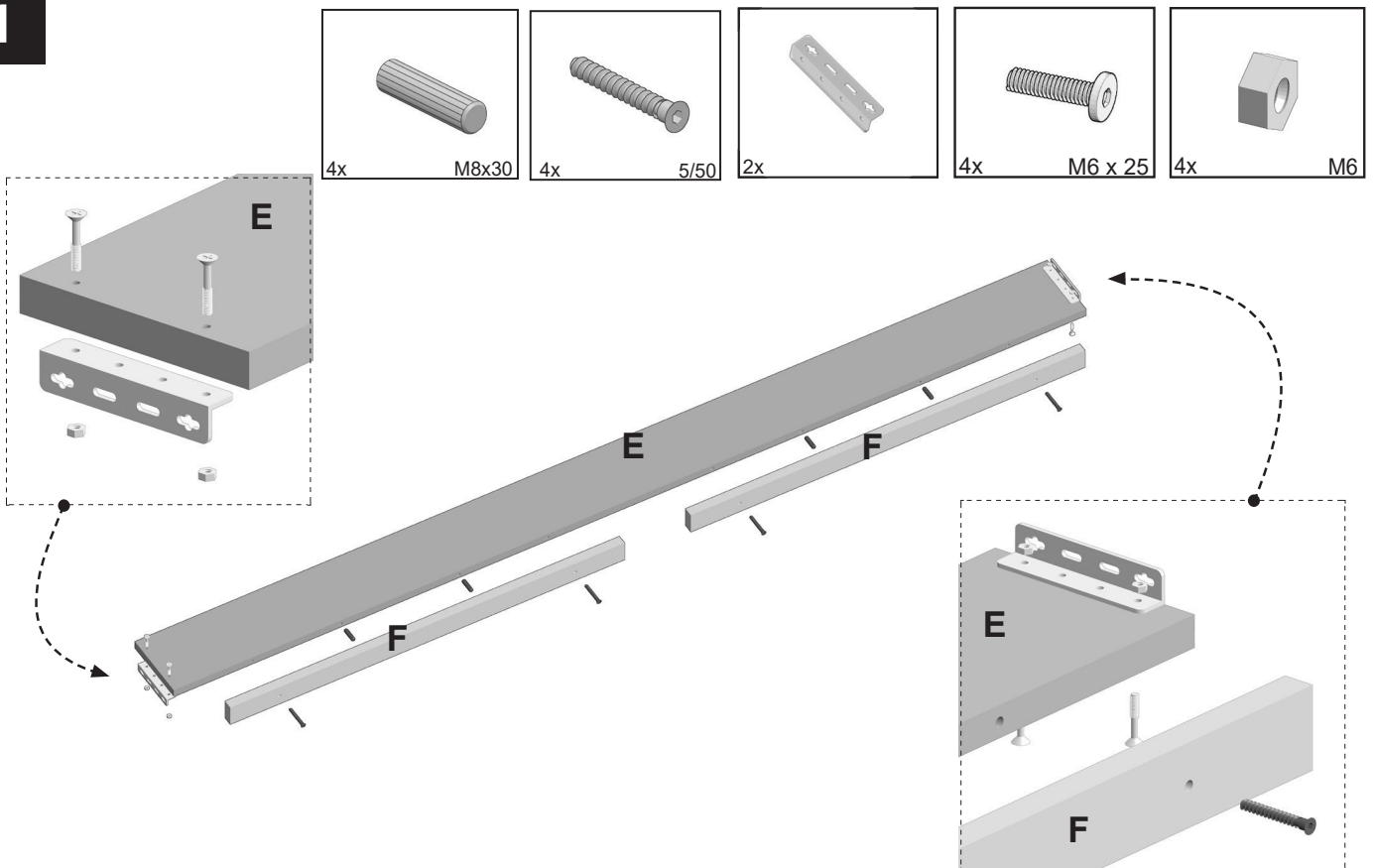

MAUDY BK

10032025

2

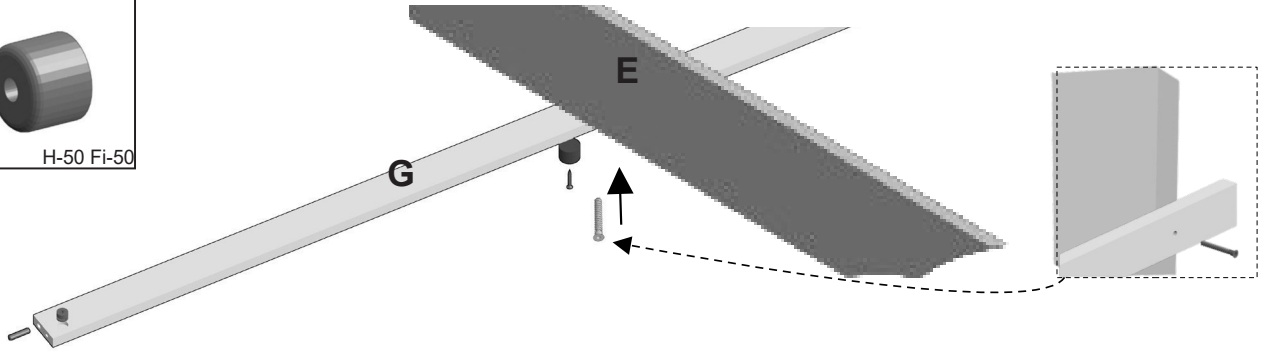
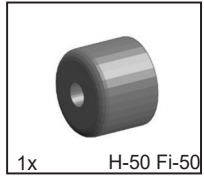
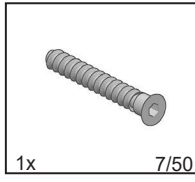
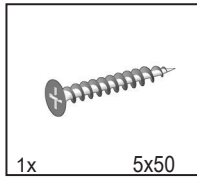
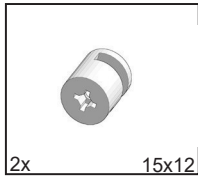
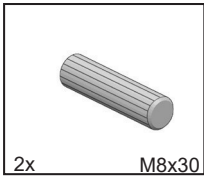

3

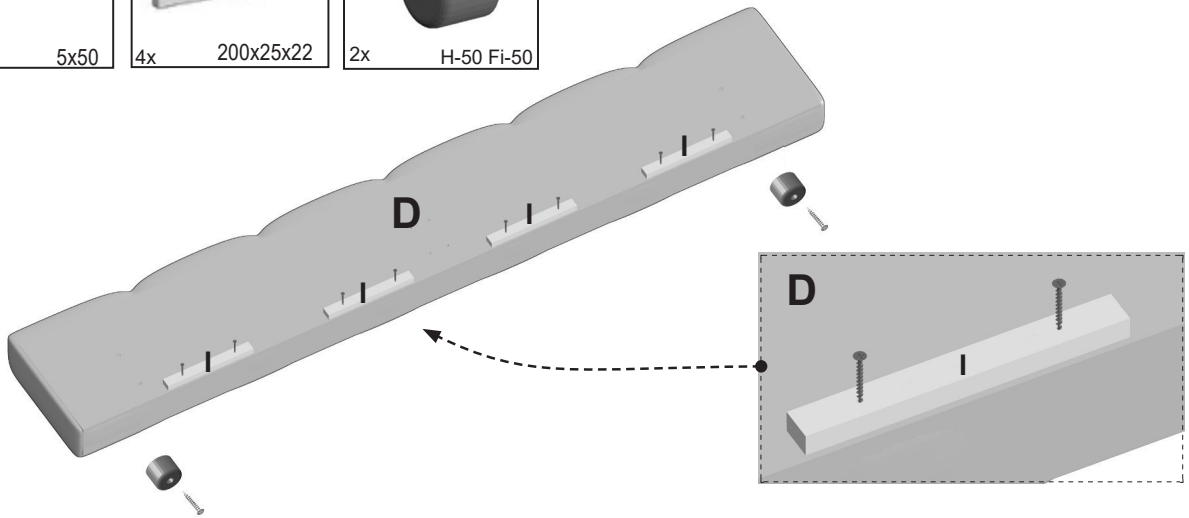
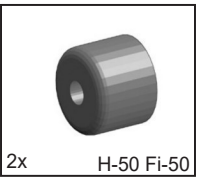
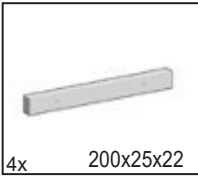
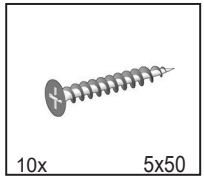

4

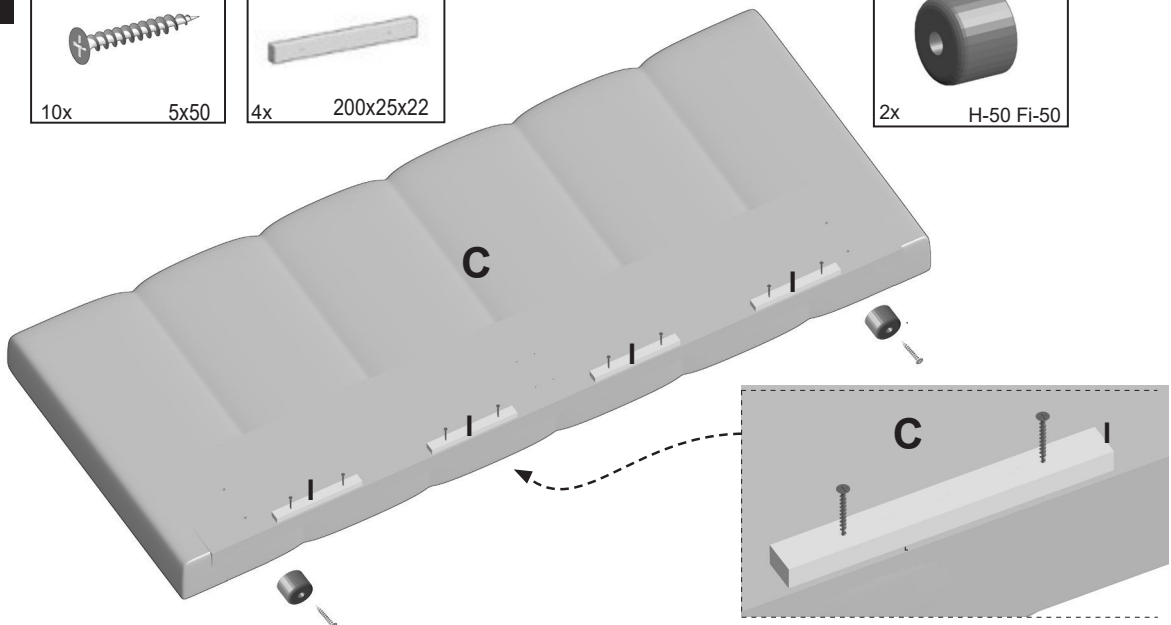
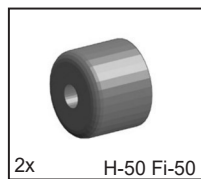
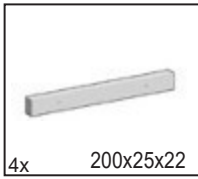
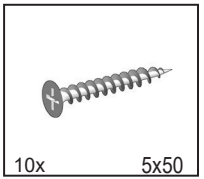

MAUDY BK

10032025

5

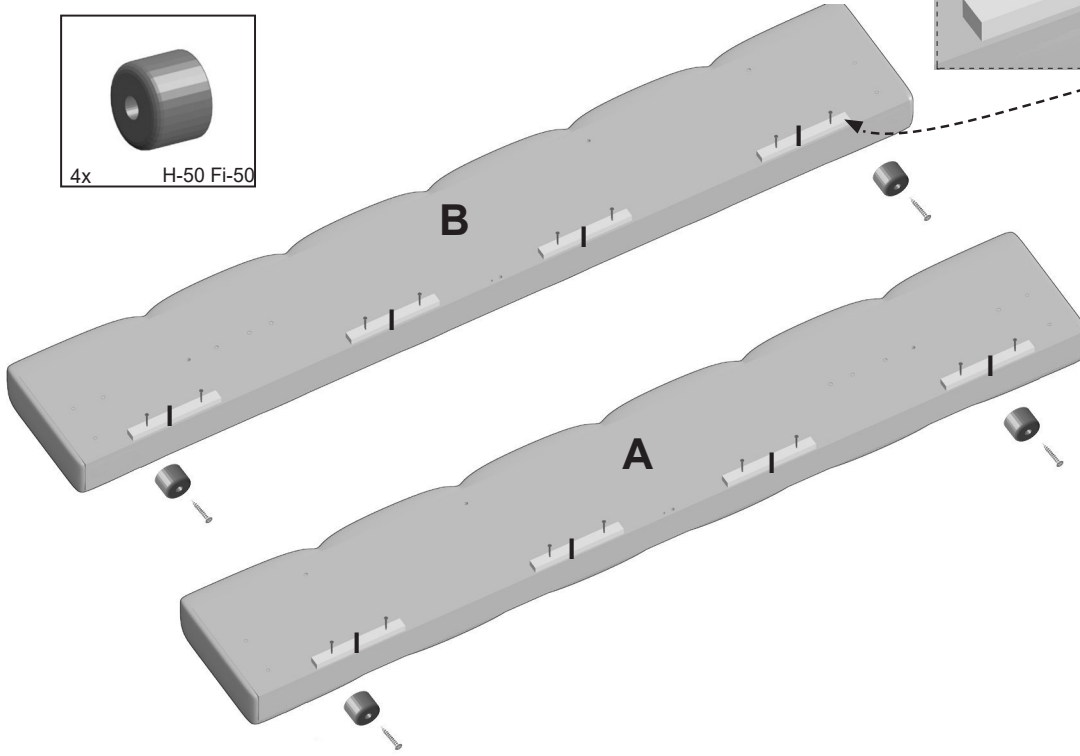
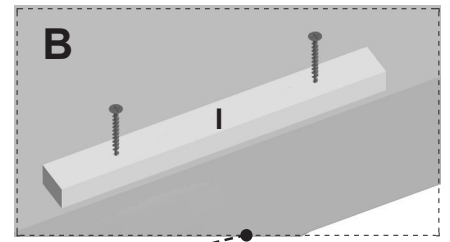
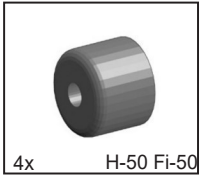
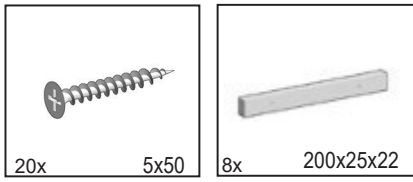

6

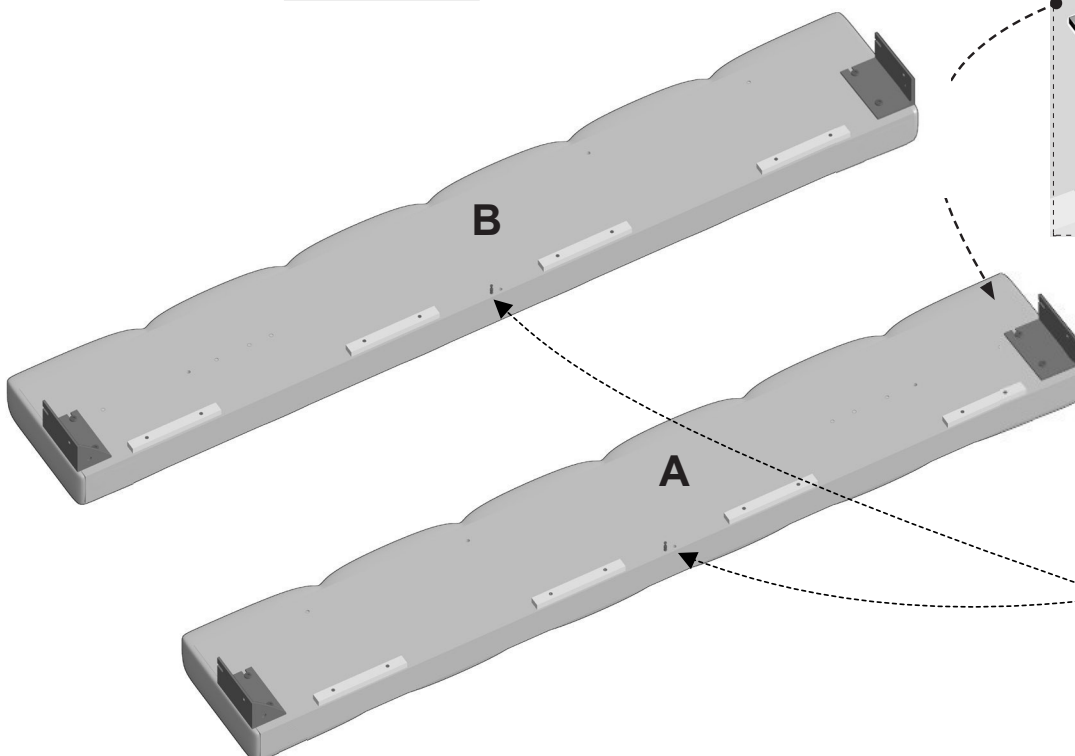
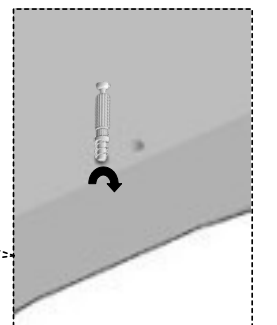
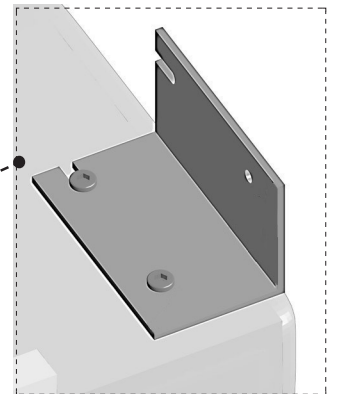
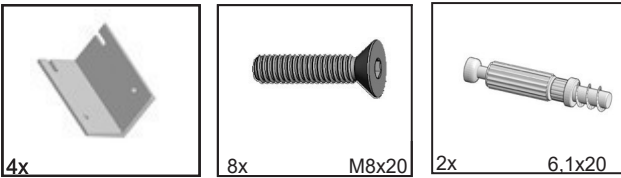

MAUDY BK

10032025

7



18x M6x50



1x DP



1x DL

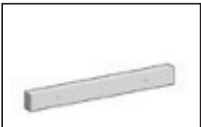

4x 512x40x32



2x 530x40x32



4x

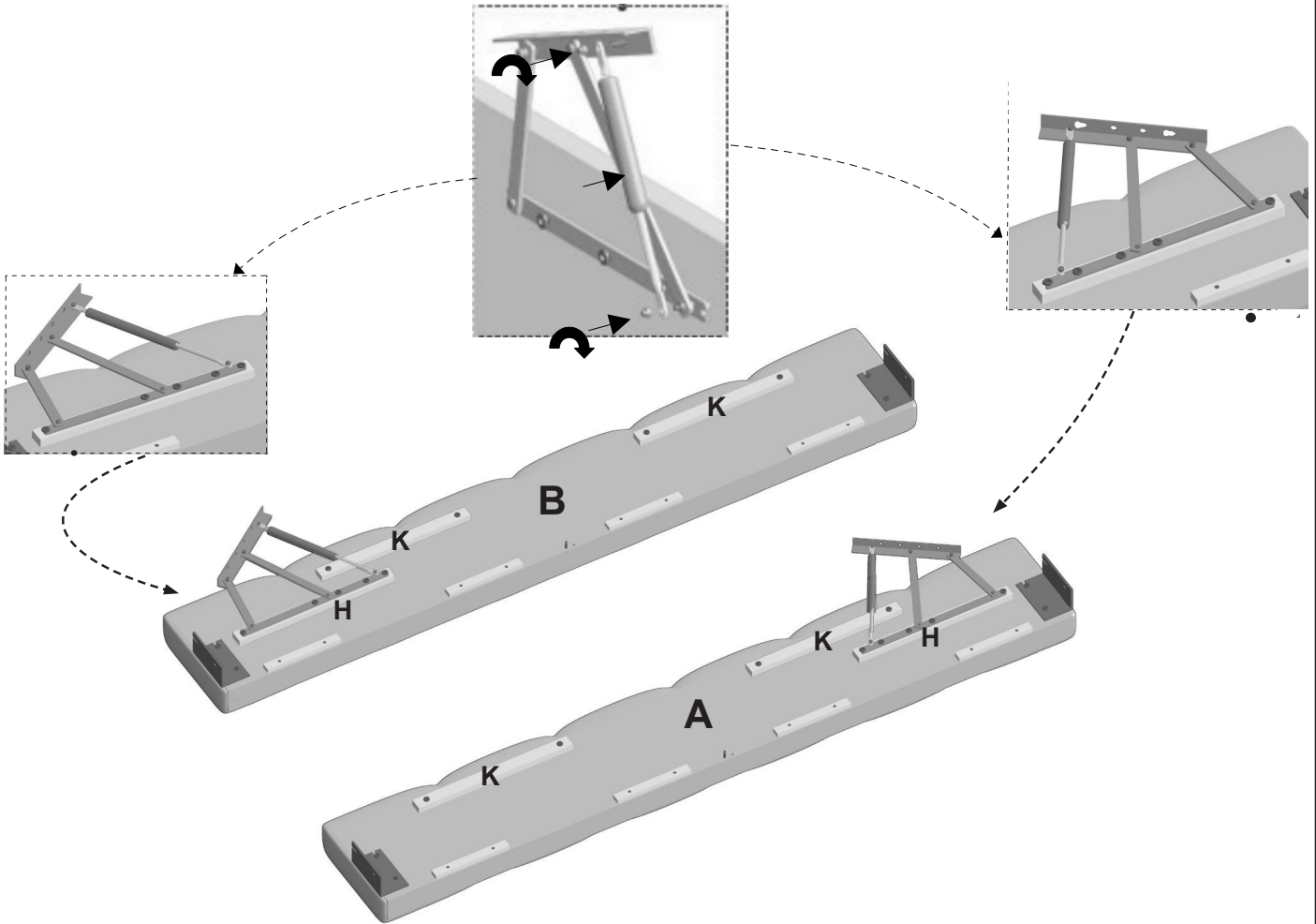

8



2x M8x30

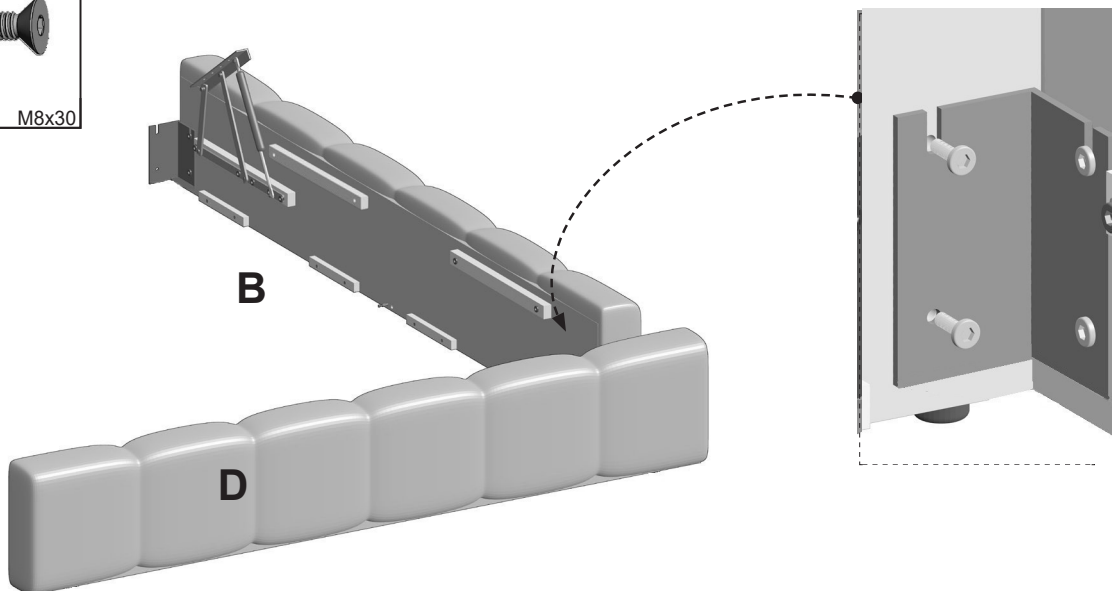

MAUDY BK

10032025

9

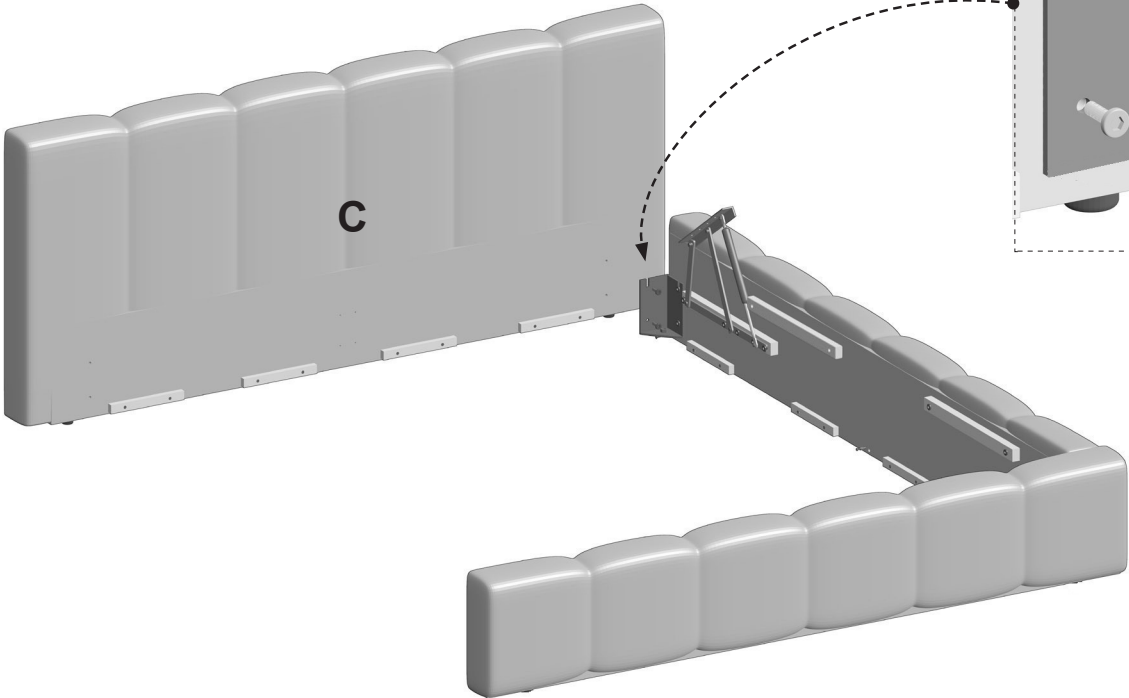
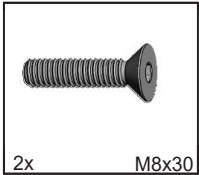

10

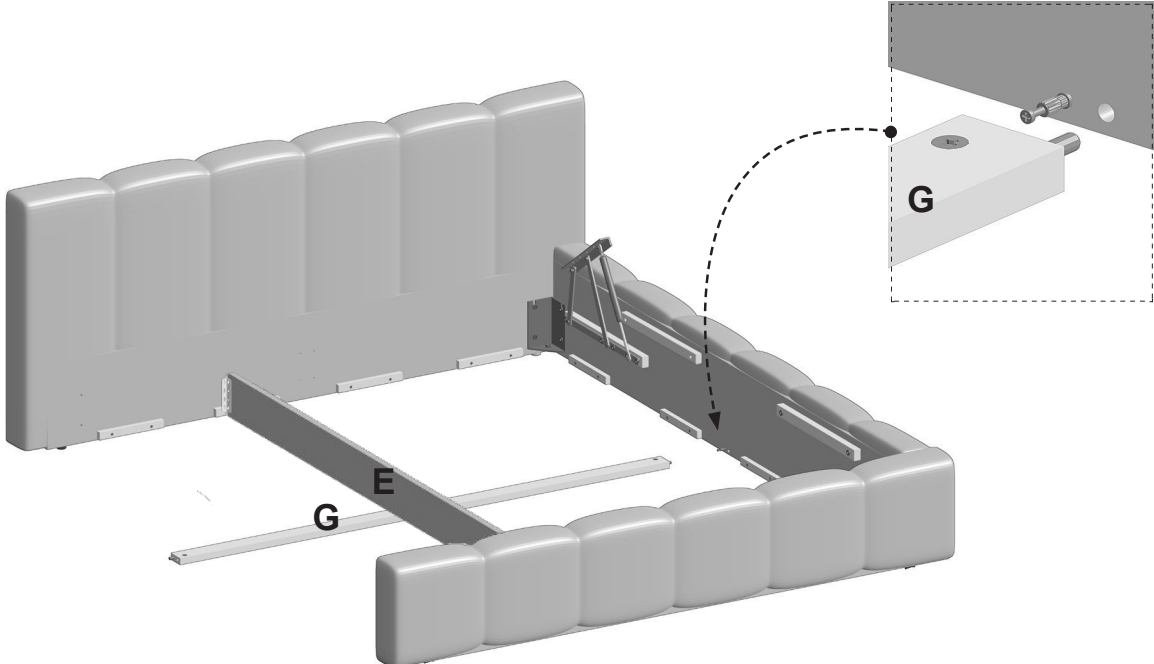

MAUDY BK

10032025

11

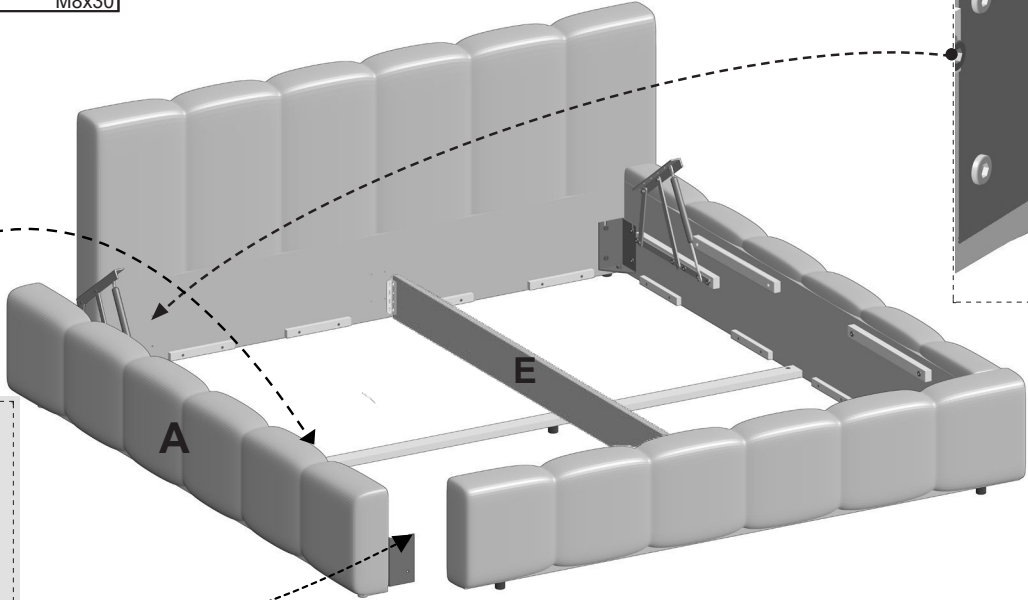
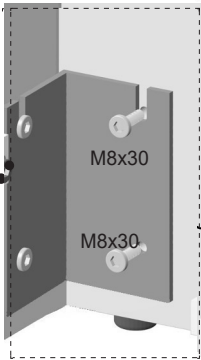
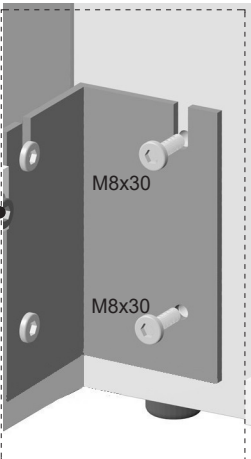
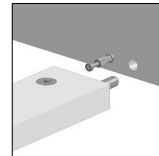
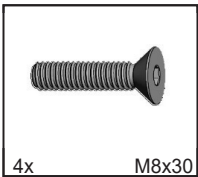

12

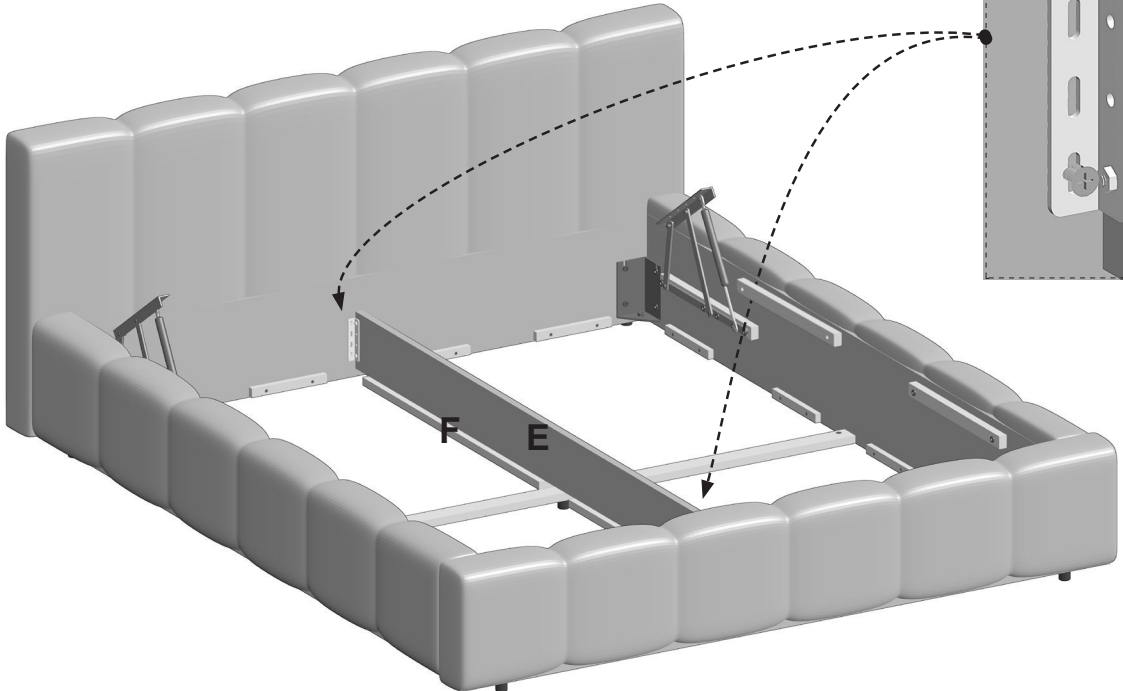
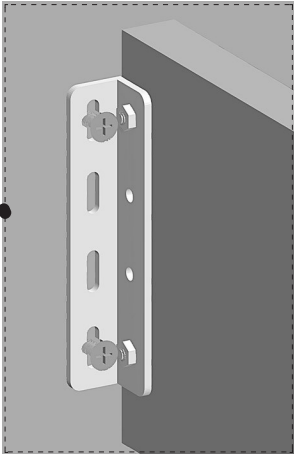
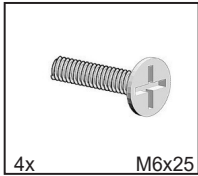

MAUDY BK

10032025

13

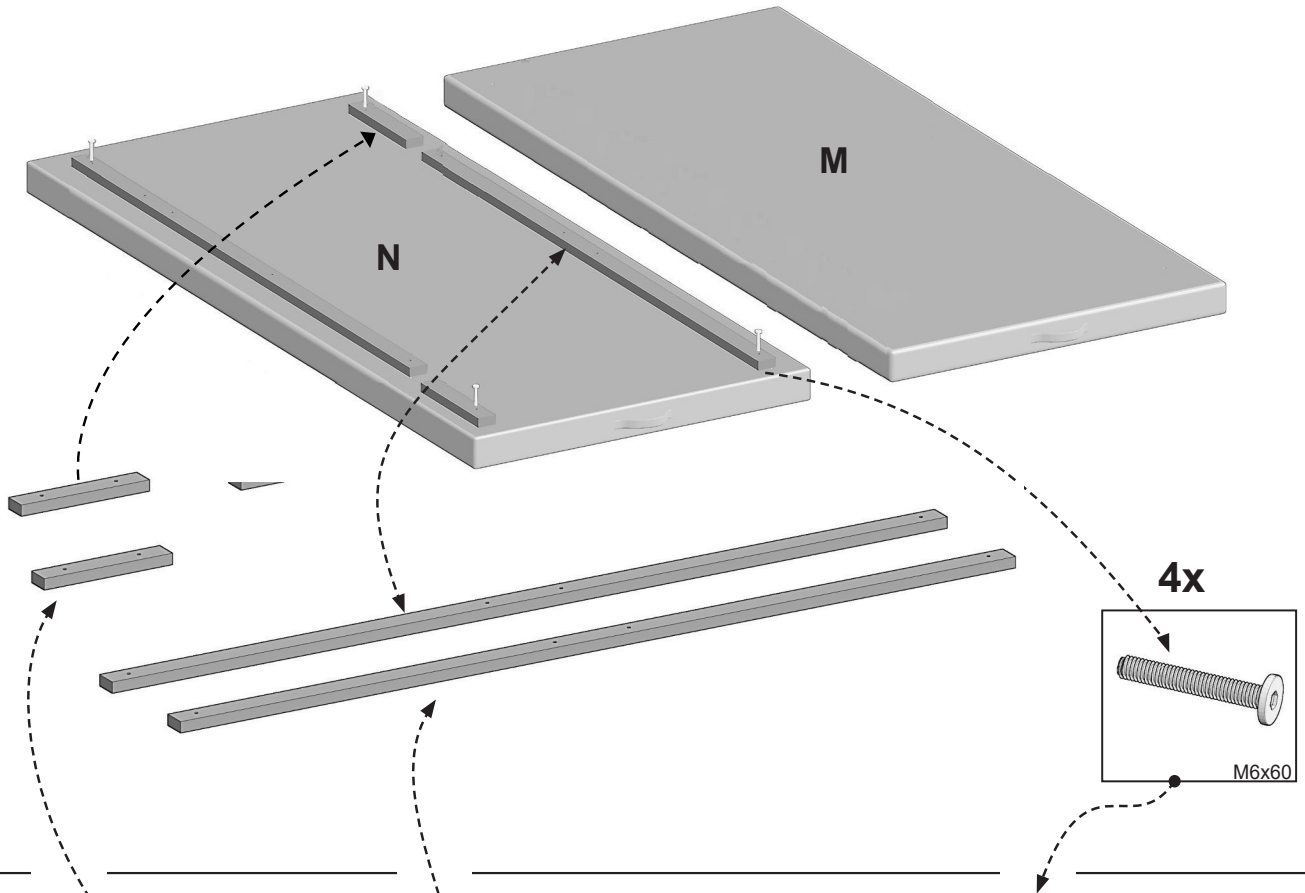

14

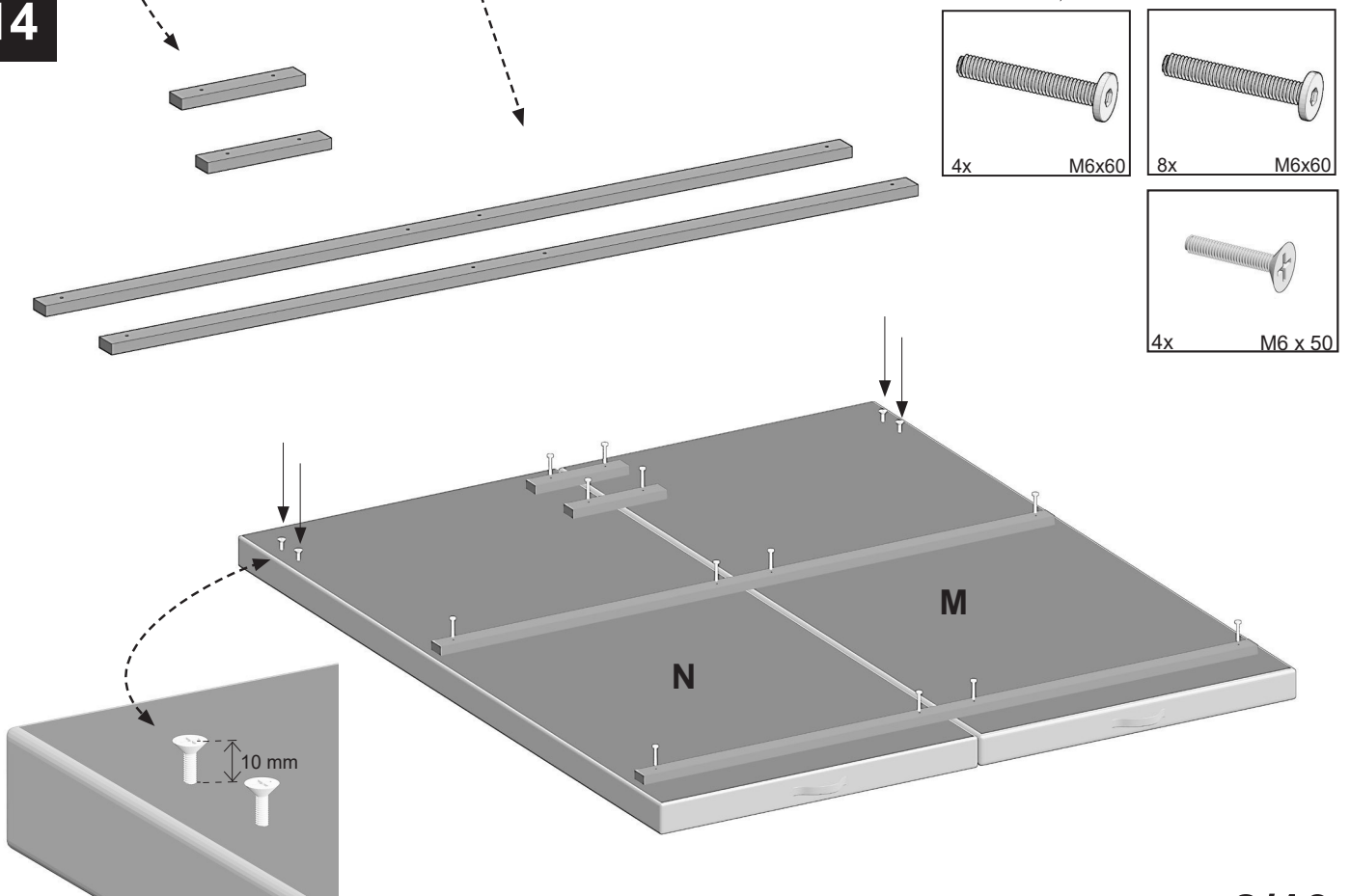

MAUDY BK

10032025

15

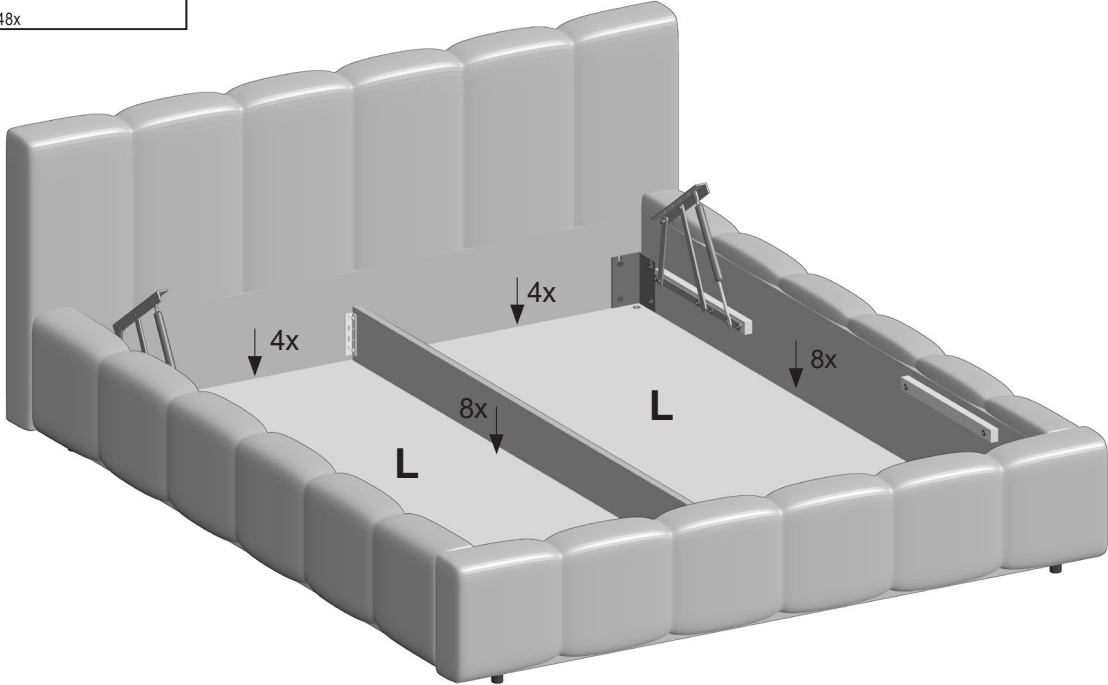
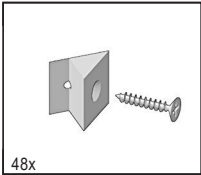

16

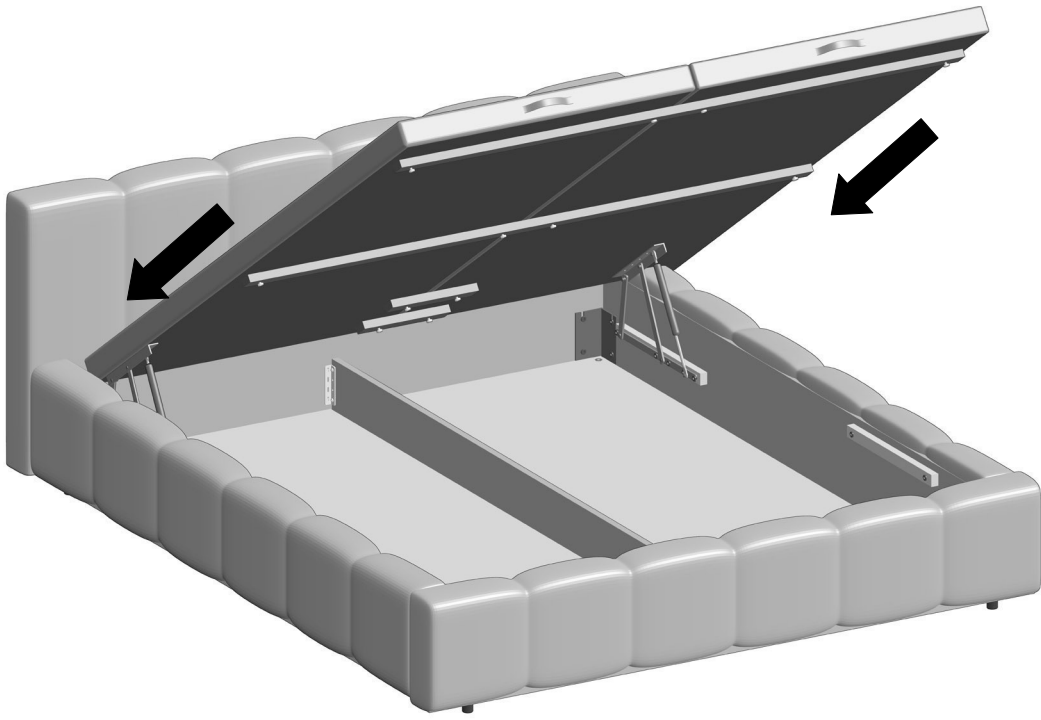

MAUDY BK

10032025

