

tvilum

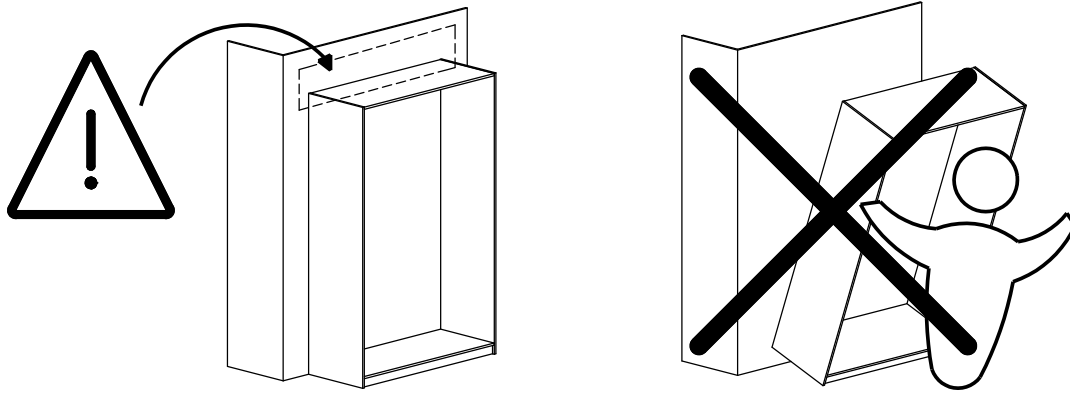

H < 2310 mm

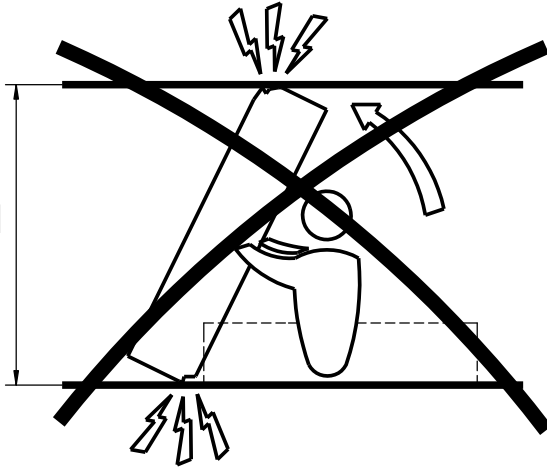

H > 2310 mm

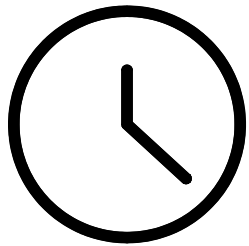

3-4 hr

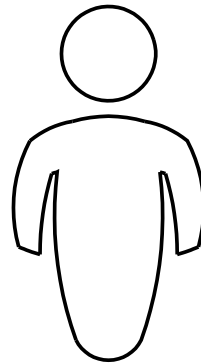

x2

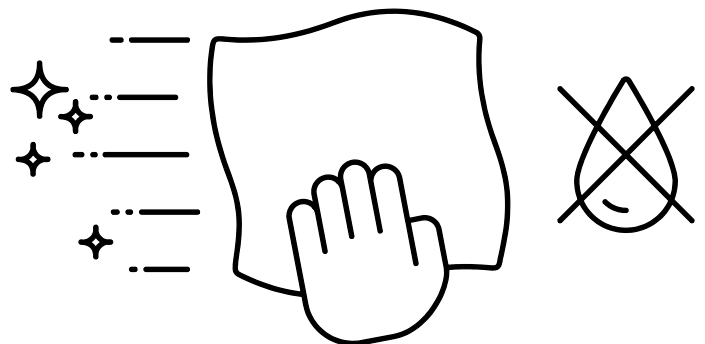
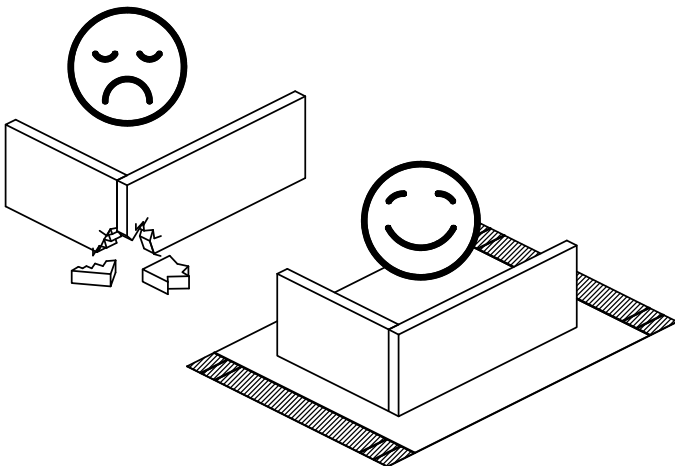

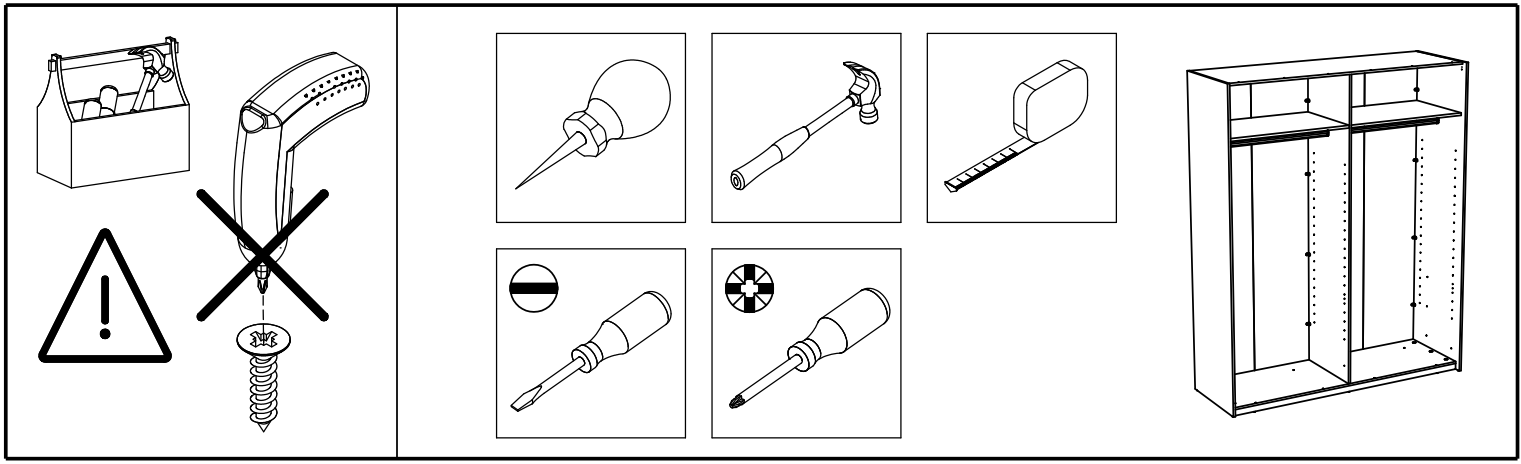

<p>0110621 x4</p> <p>0.71x1.79x0.47" 18x45,5x12 mm</p>	<p>0110901 x1</p> <p>Ø0.87x0.02" Ø22x0,5 mm</p>	<p>0111023 x16</p> <p>0.93x0.67x0.87" 23,5x17x22 mm</p>	<p>0111229 x8</p> <p>Ø0.79x0.53/0.49" Ø20x13,5/12,5 mm</p>	<p>0111230 x8</p> <p>Ø0.26/Ø0.2x0.65" Ø6,5/Ø5x16,5 mm</p>
<p>0113451 x2</p> <p>1.22x3.98x0.59x0.05" 31x101x15x1,3 mm</p>	<p>0121607 x16</p> <p>Ø0.79xØ0.39x0.10" Ø20/Ø10x2,5 mm</p>	<p>0120203 x28</p> <p>Ø0.2x1.18" Ø5x30 mm</p>	<p>0125440 x4</p> <p>Ø0.16x0.51" Ø4x13 mm</p>	<p>0125604 x8</p> <p>Ø0.2x1.5" Ø5x38 mm</p>
<p>0126020 x8</p> <p>Ø0.23x0.35" Ø5,8x9 mm</p>	<p>0126039 x16</p> <p>Ø0.25x0.47" Ø6,3x12 mm</p>	<p>0131513 x16</p> <p>Ø0.30x1.73/1.34" Ø7,5x44/34 mm</p>	<p>0131687 x16</p> <p>Ø0.59x0.37" Ø15x9,5 mm</p>	<p>0163001 x10</p> <p>Ø0.47x0.16" Ø12x4 mm</p>
<p>0172585 x2</p> <p>34.06x0.59x1.12" 865x15x28,5 mm</p>				

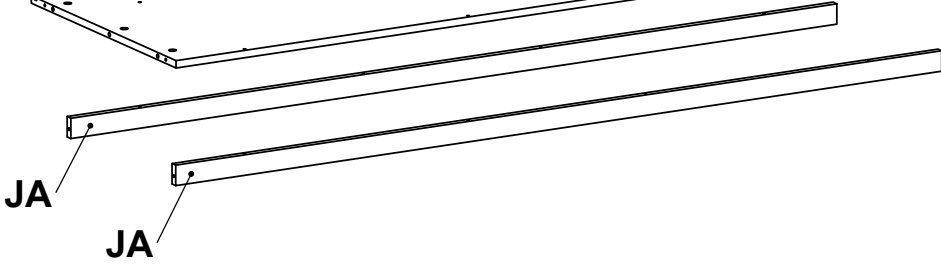
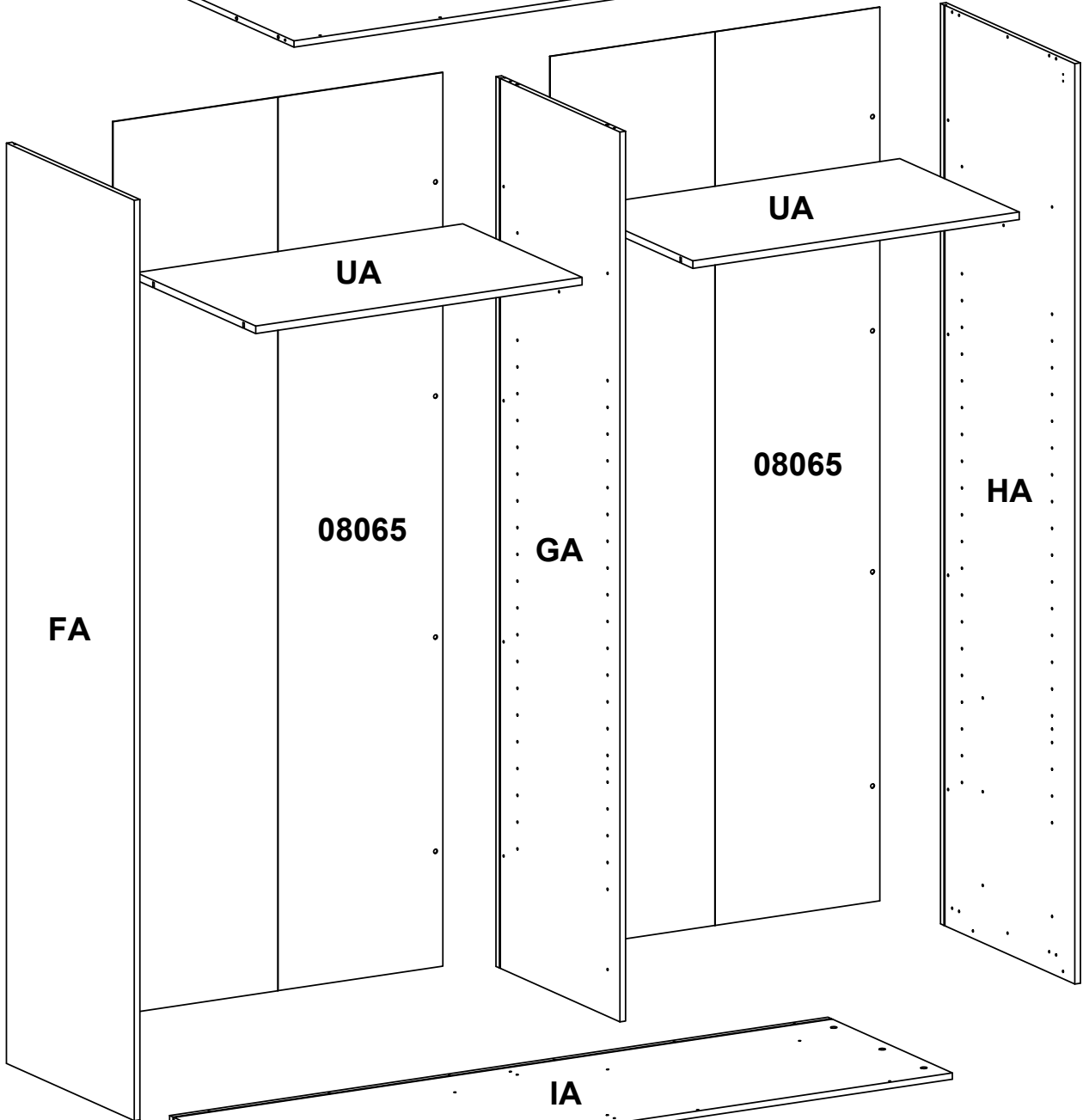
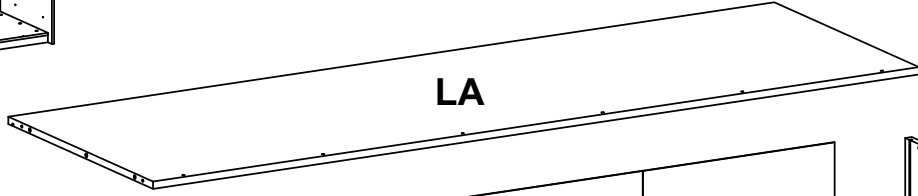
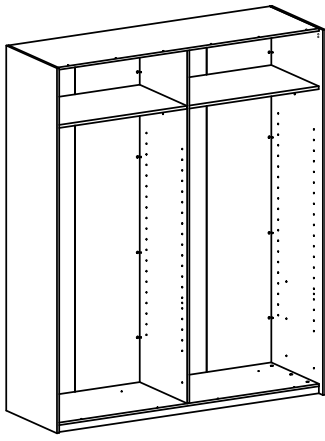

BOX 1/3

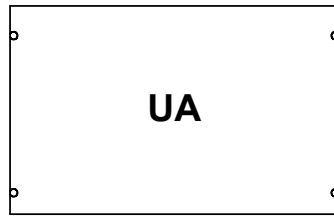

UA

870x551x18mm

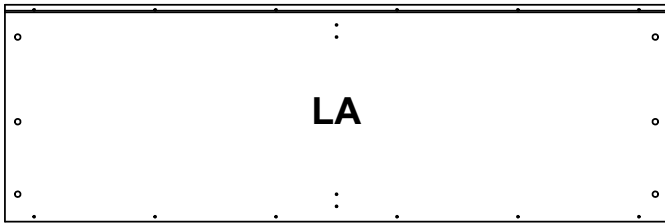

LA

1755x574x15mm

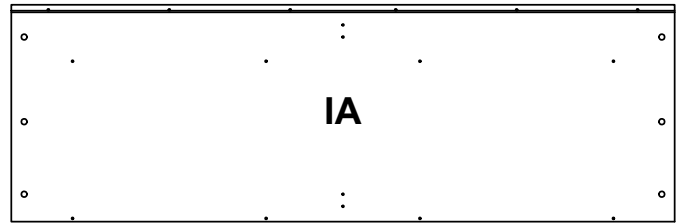

IA

1755x574x15mm

BOX 2/3



UA

870x551x18mm

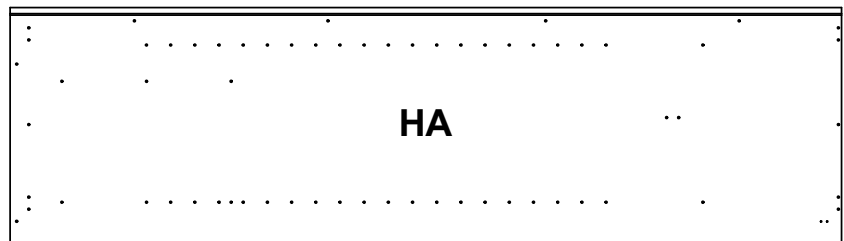

HA

2200x620x15mm

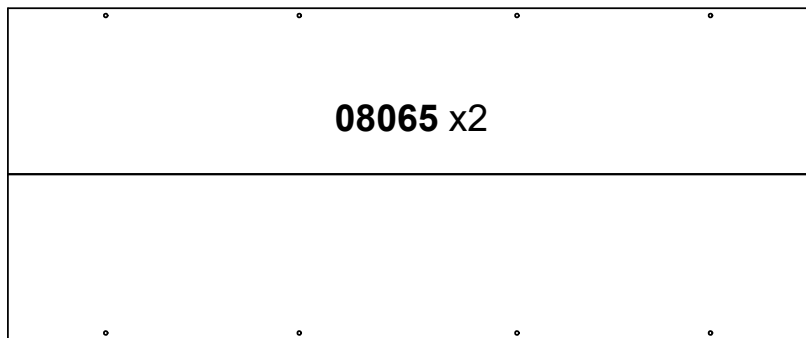

08065 x2

2136x879x2,5mm

BOX 3/3

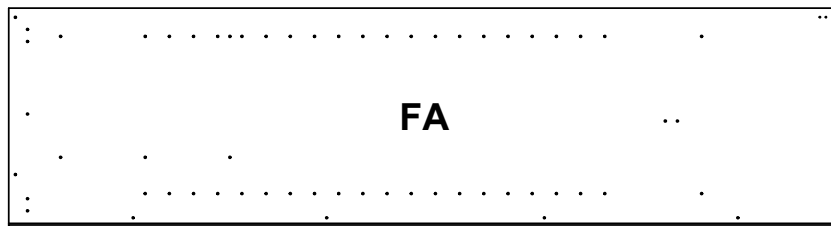

FA

2200x590x15mm

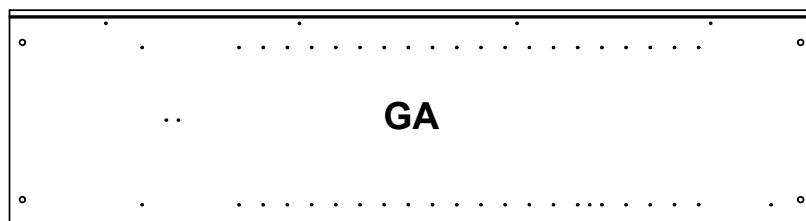





GA

2127x572x15mm

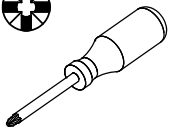
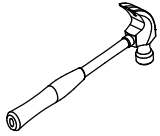

1755x42x15mm

JA x2

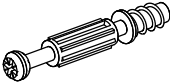
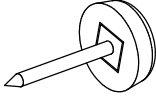
1	0131513 x6	0163001 x2				  
			$\text{Ø}0.30 \times 1.73 / 1.34"$ $\text{Ø}7.5 \times 44 / 34 \text{ mm}$	$\text{Ø}0.47 \times 0.16"$ $\text{Ø}12 \times 4 \text{ mm}$		

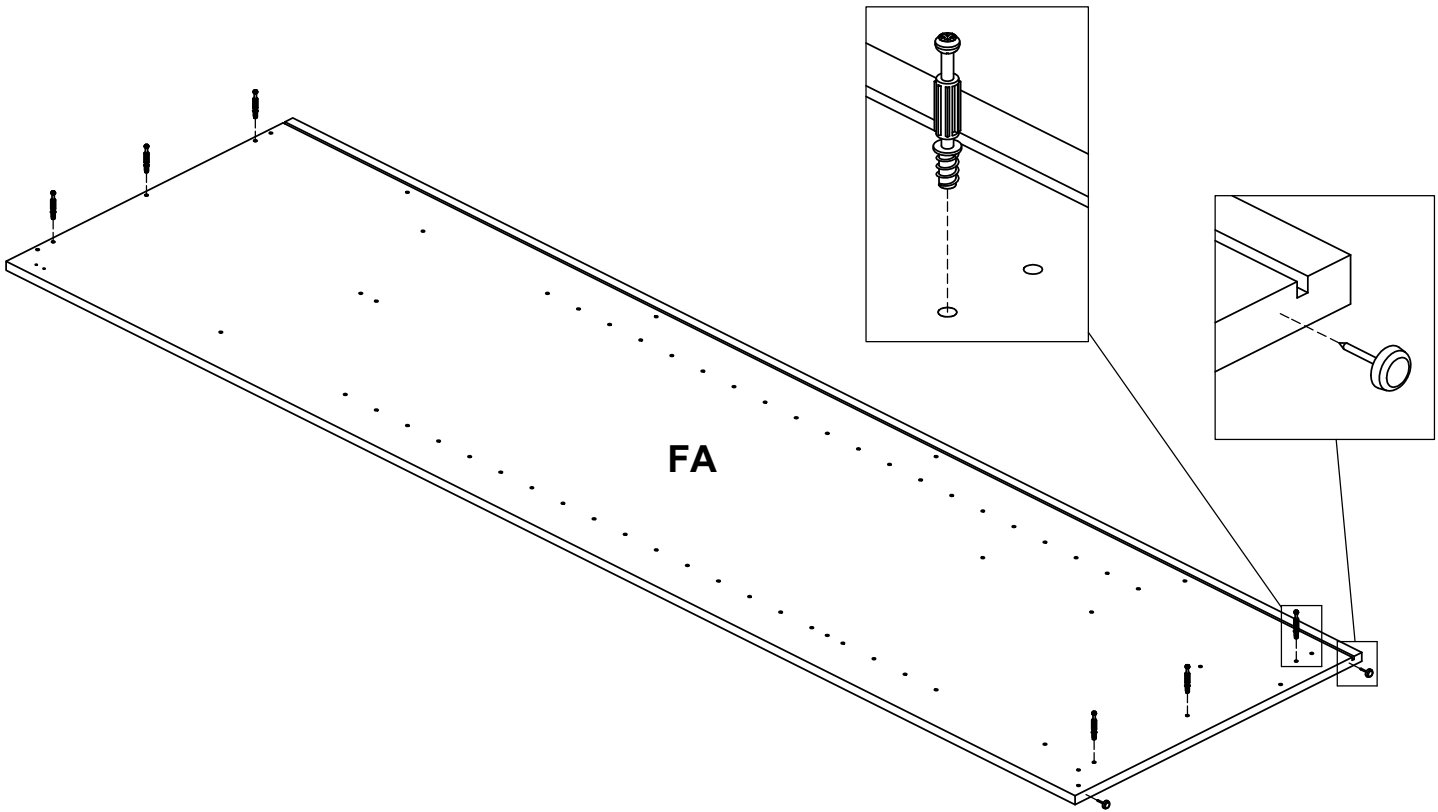

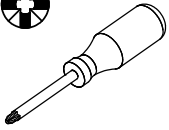
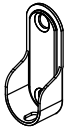
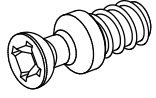
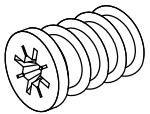
2	0110621 x1	0111230 x2	0126020 x2		
				$0.71 \times 1.79 \times 0.47"$ $18 \times 45.5 \times 12 \text{ mm}$	$\text{Ø}0.26 / \text{Ø}0.2 \times 0.65"$ $\text{Ø}6.5 / \text{Ø}5 \times 16.5 \text{ mm}$

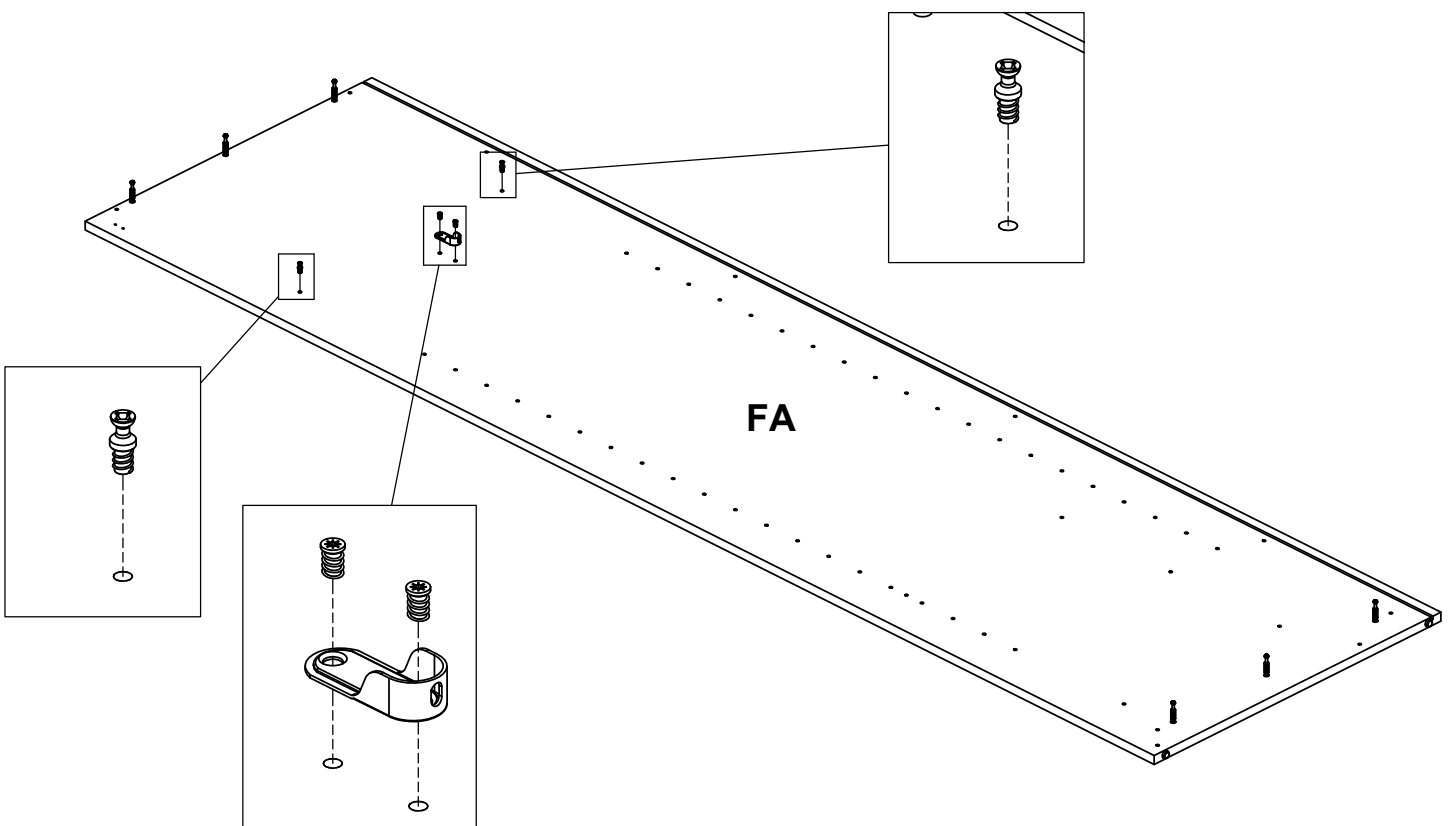

3

0131513

x6

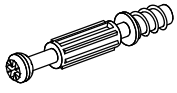

Ø0.30x1.73/1.34"
Ø7,5x44/34 mm

0163001

x2

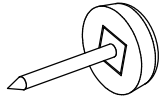

Ø0.47x0.16"
Ø12x4 mm

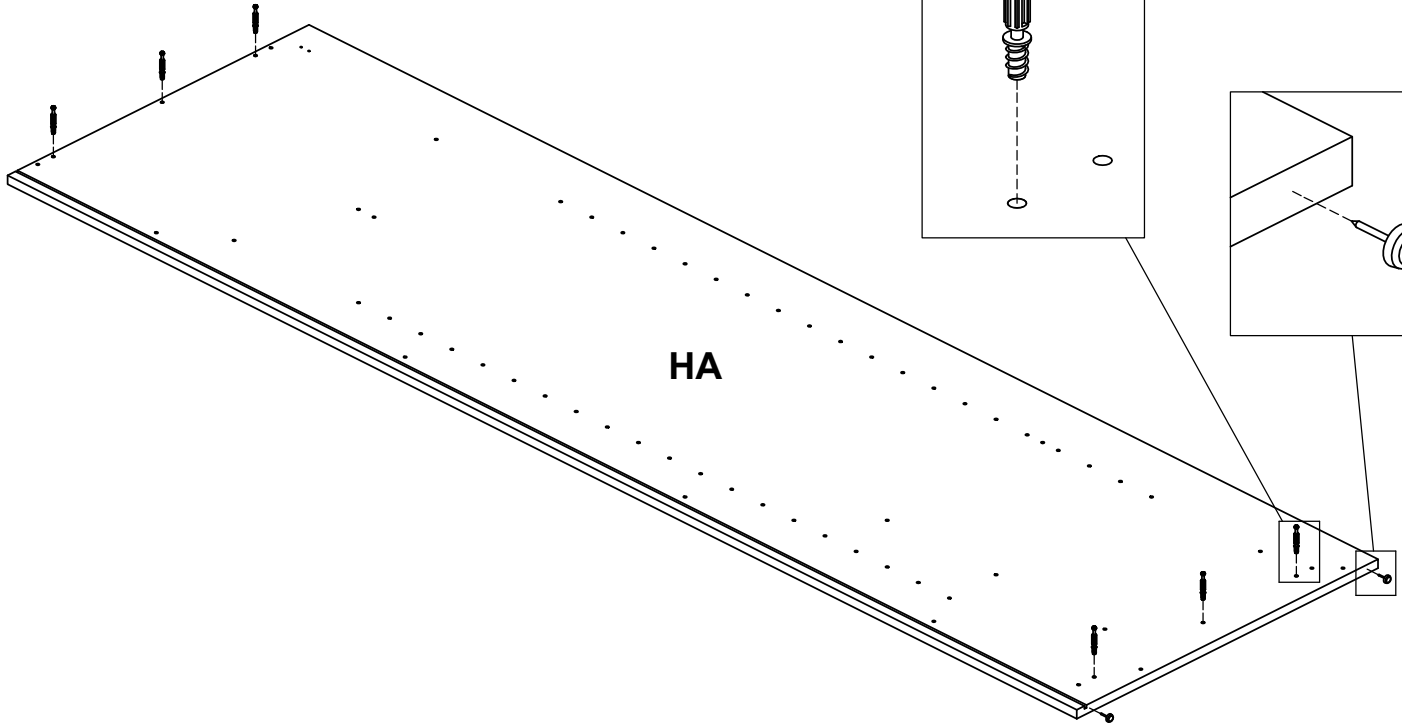
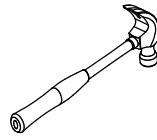
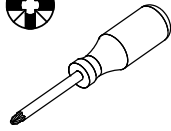

4

0110621

x1

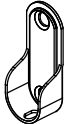

0.71x1.79x0.47"
18x45,5x12 mm

0111230

x2

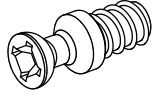

Ø0.26/Ø0.2x0.65"
Ø6,5/Ø5x16,5 mm

0126020

x2

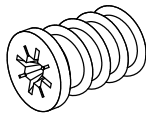

Ø0.23x0.35"
Ø5,8x9 mm

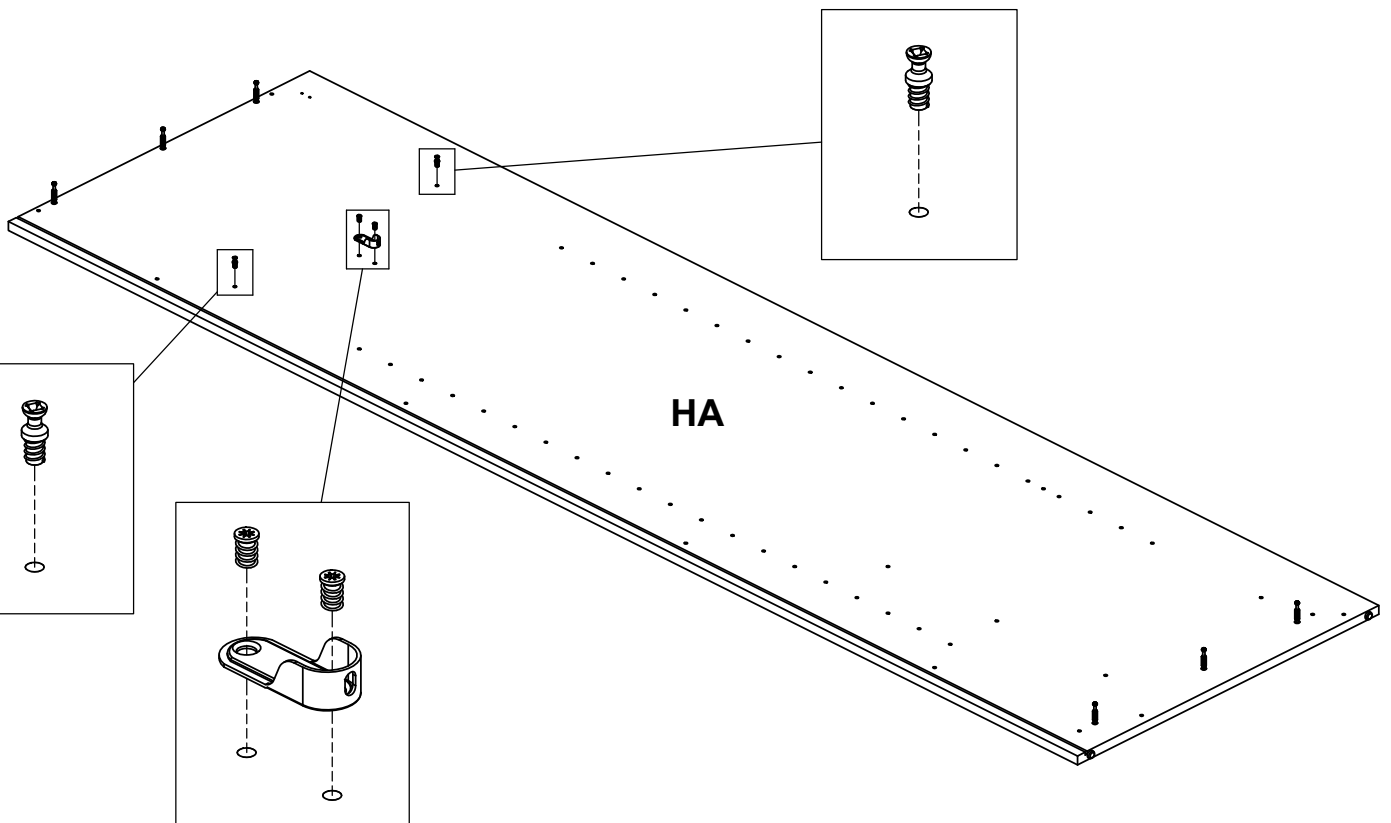
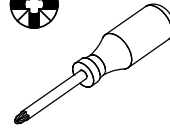

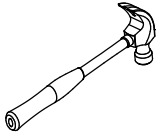
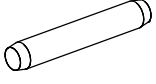
5	0120203 x4	
	 Ø0.2x1.18" Ø5x30 mm	

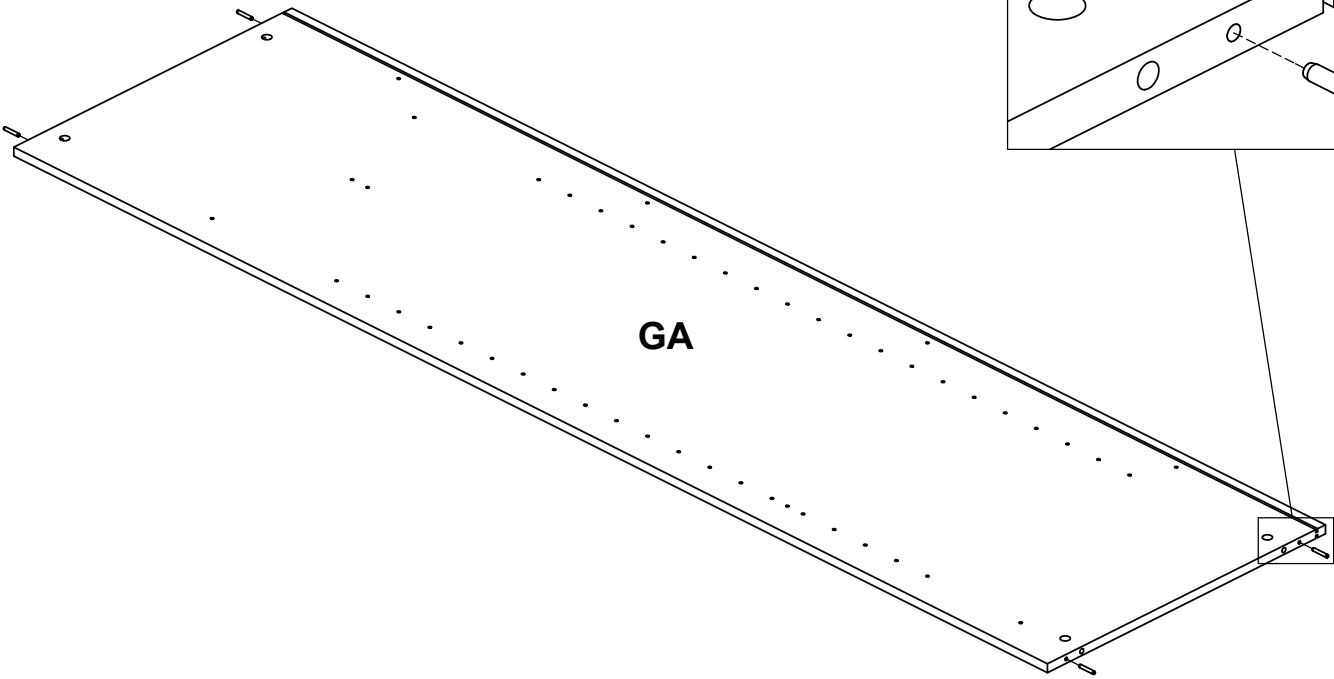

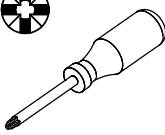
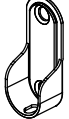
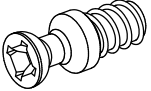
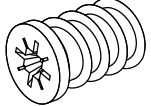
6	0110621 x1	0111230 x2	0126020 x2	
	 0.71x1.79x0.47" 18x45,5x12 mm	 Ø0.26/Ø0.2x0.65" Ø6,5/Ø5x16,5 mm	 Ø0.23x0.35" Ø5,8x9 mm	

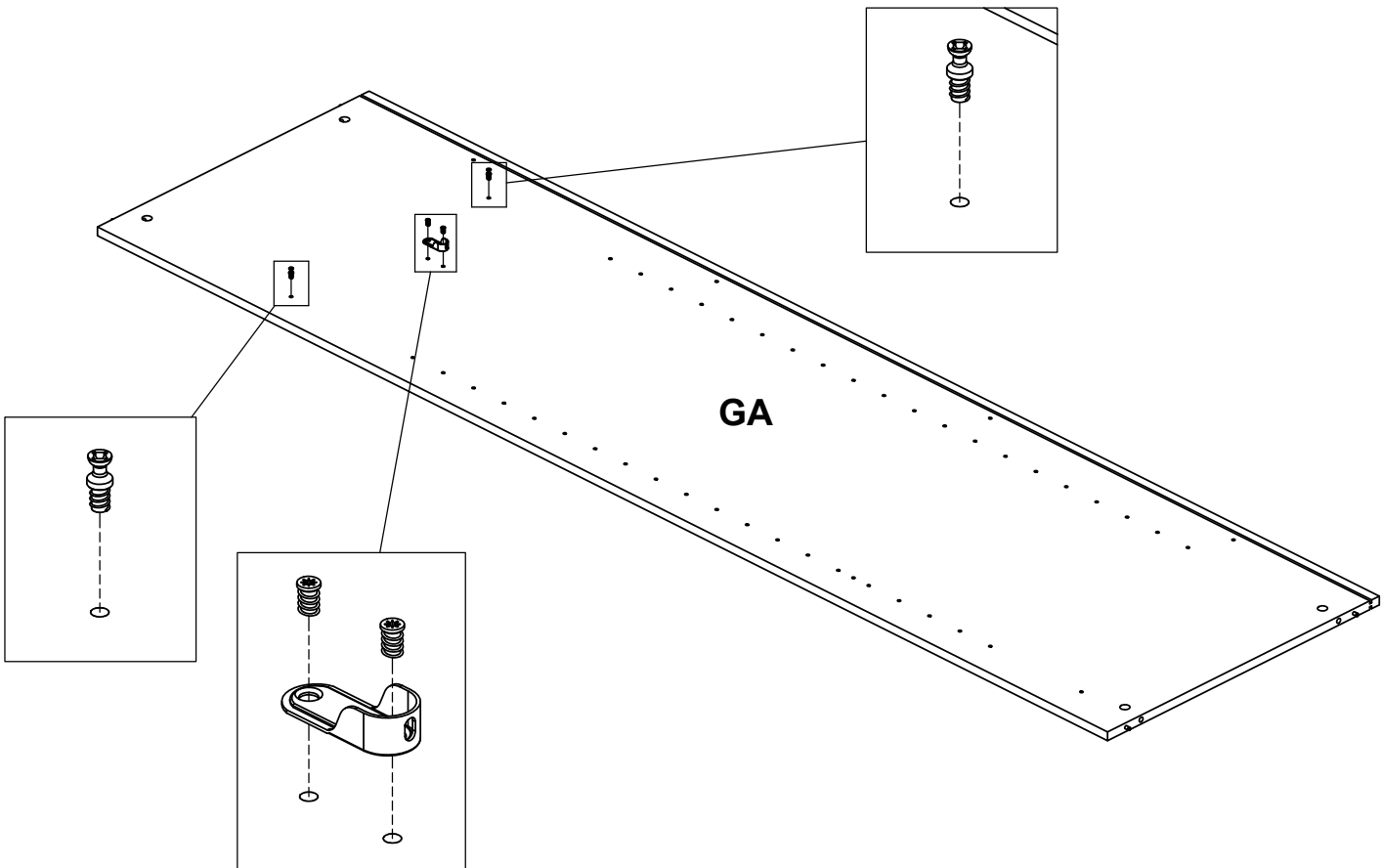

7

0110621 **x1**
0.71x1.79x0.47"
18x45,5x12 mm

0111230 **x2**
Ø0.26/Ø0.2x0.65"
Ø6,5/Ø5x16,5 mm

0126020 **x2**
Ø0.23x0.35"
Ø5,8x9 mm

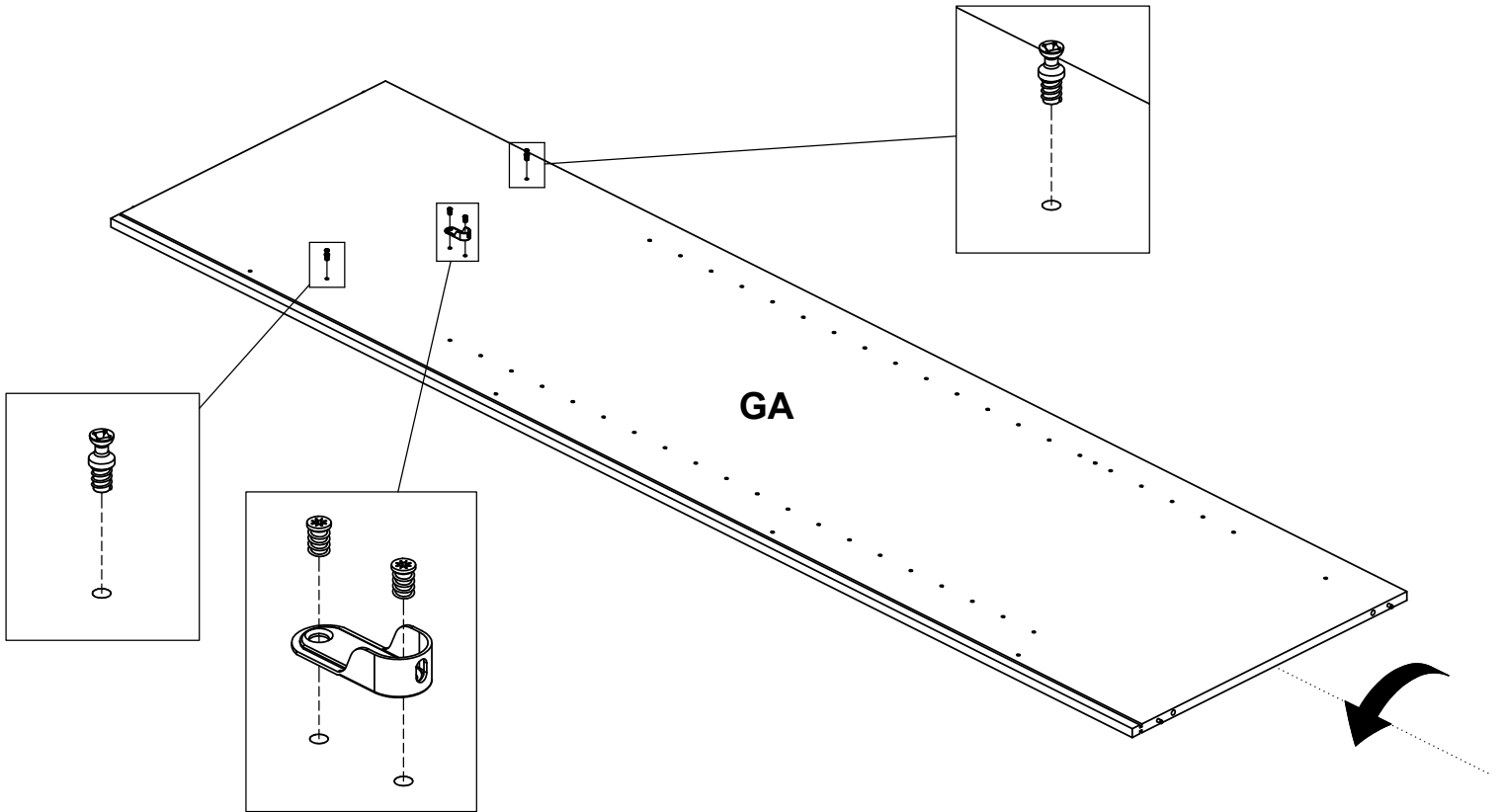
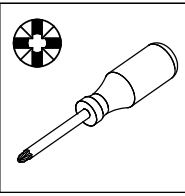

8

0111229 **x8**
Ø0.79x0.53/0.49"
Ø20x13,5/12,5 mm

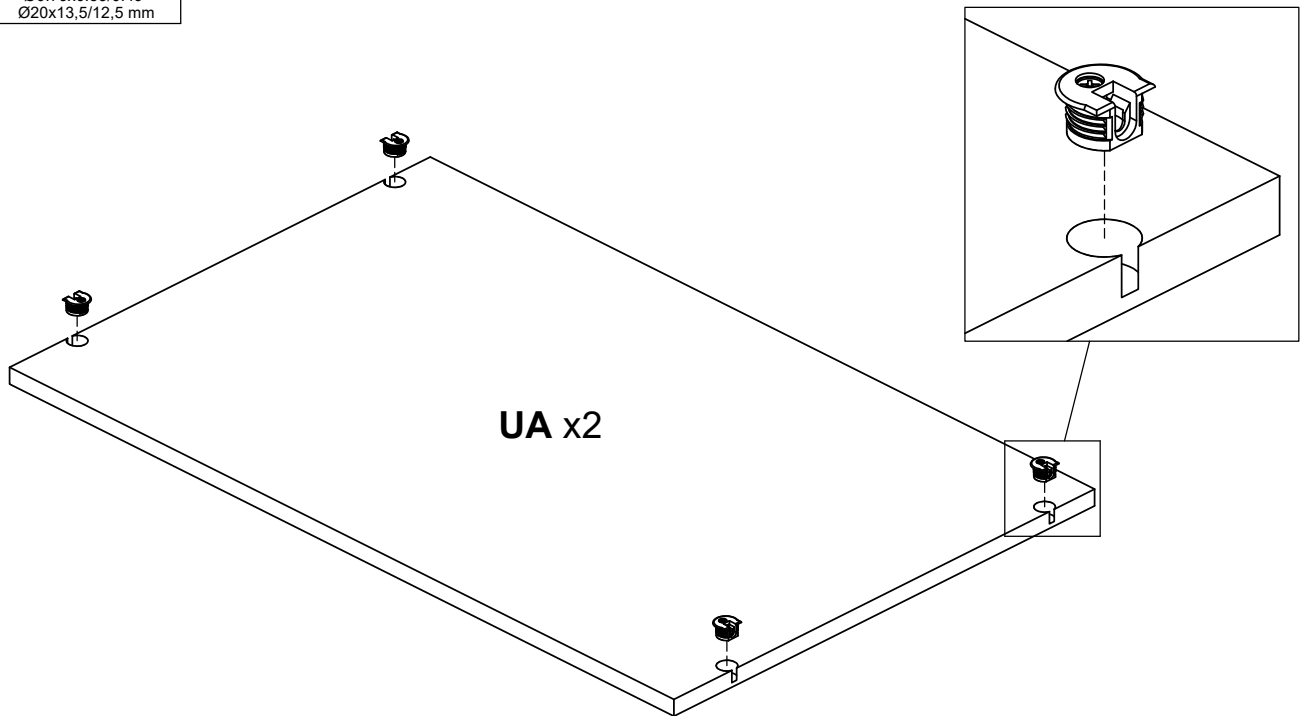

9

0120203

x10

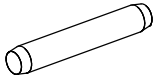

Ø0.2x1.18"
Ø5x30 mm

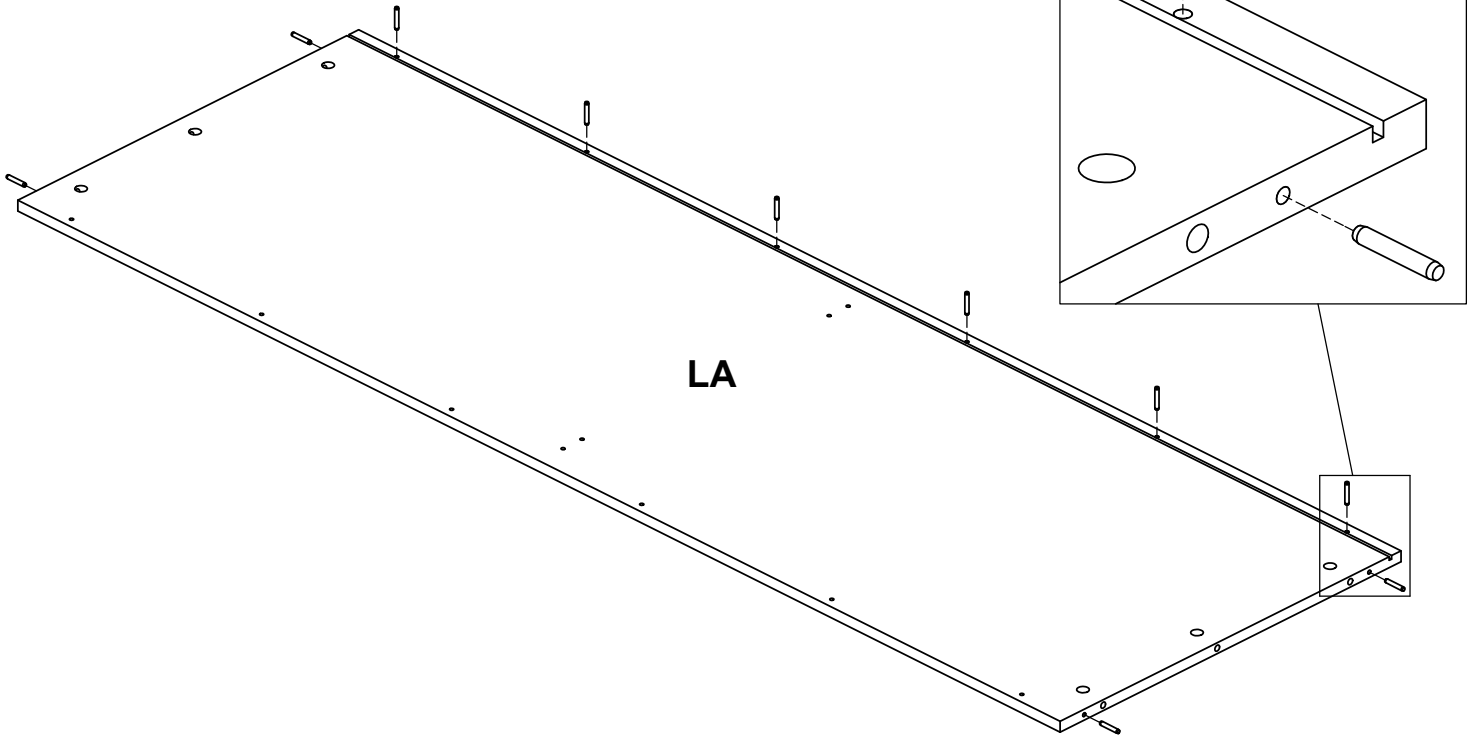
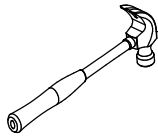

10

0131513

x2

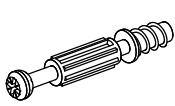

Ø0.30x1.73/1.34"
Ø7.5x44/34 mm

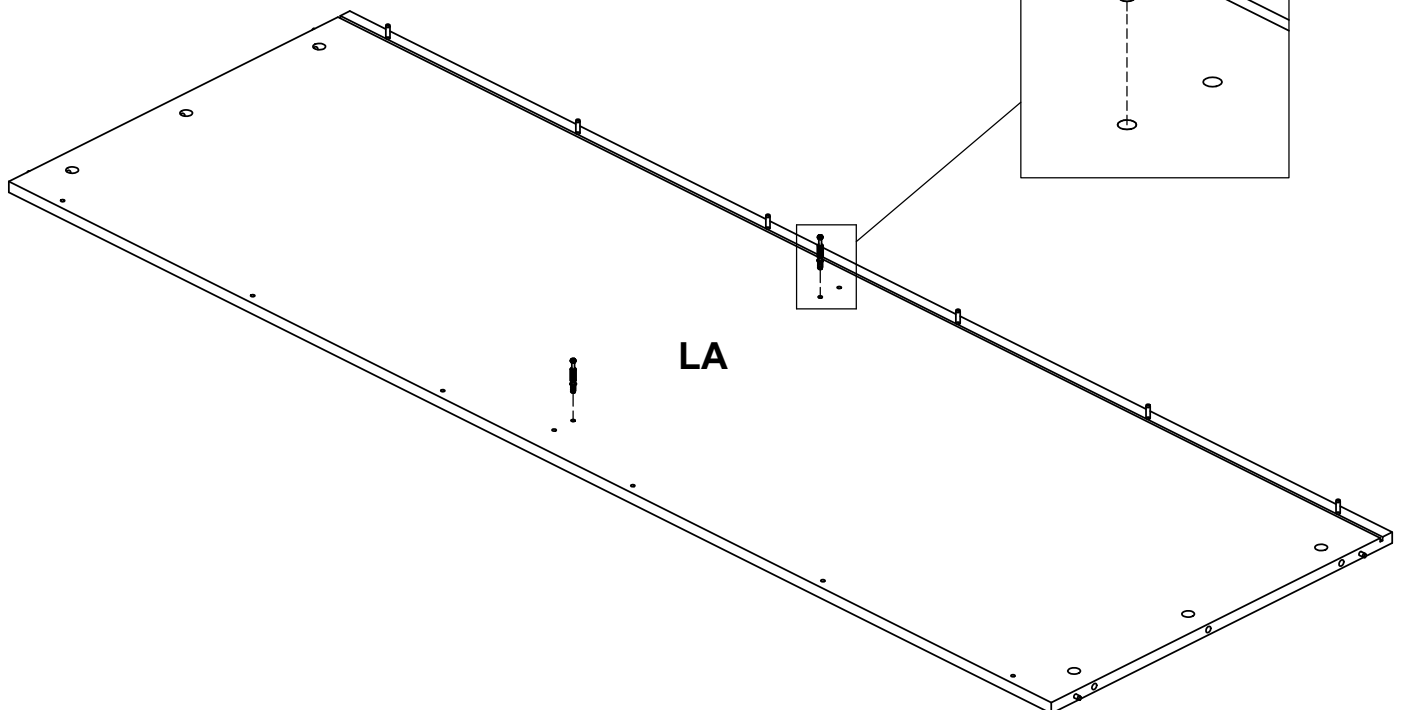
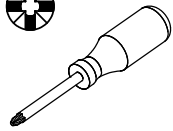

11

0120203

x10

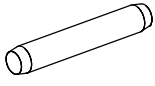

Ø0.2x1.18"
Ø5x30 mm

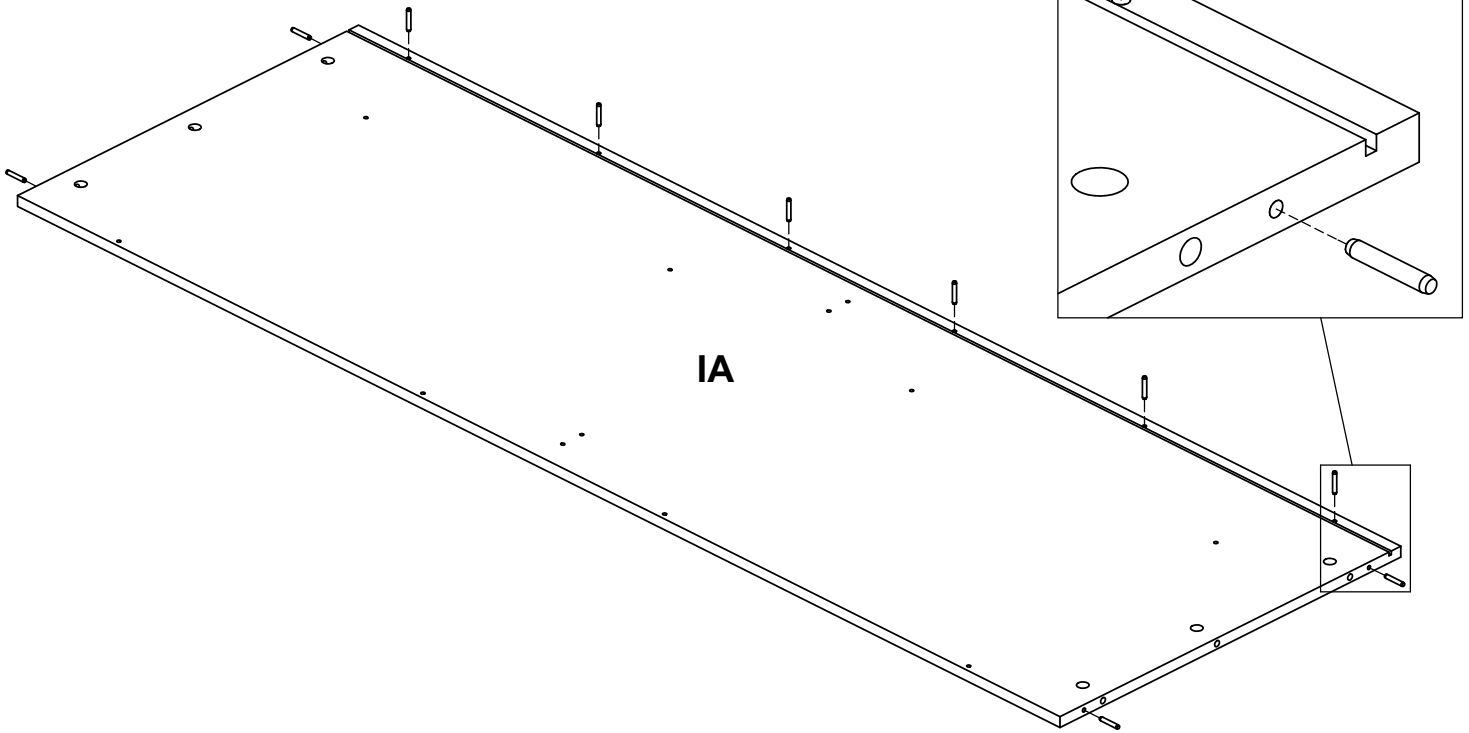
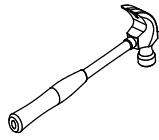

IA

12

0131513

x2

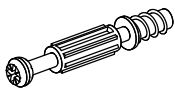

Ø0.30x1.73/1.34"
Ø7.5x44/34 mm

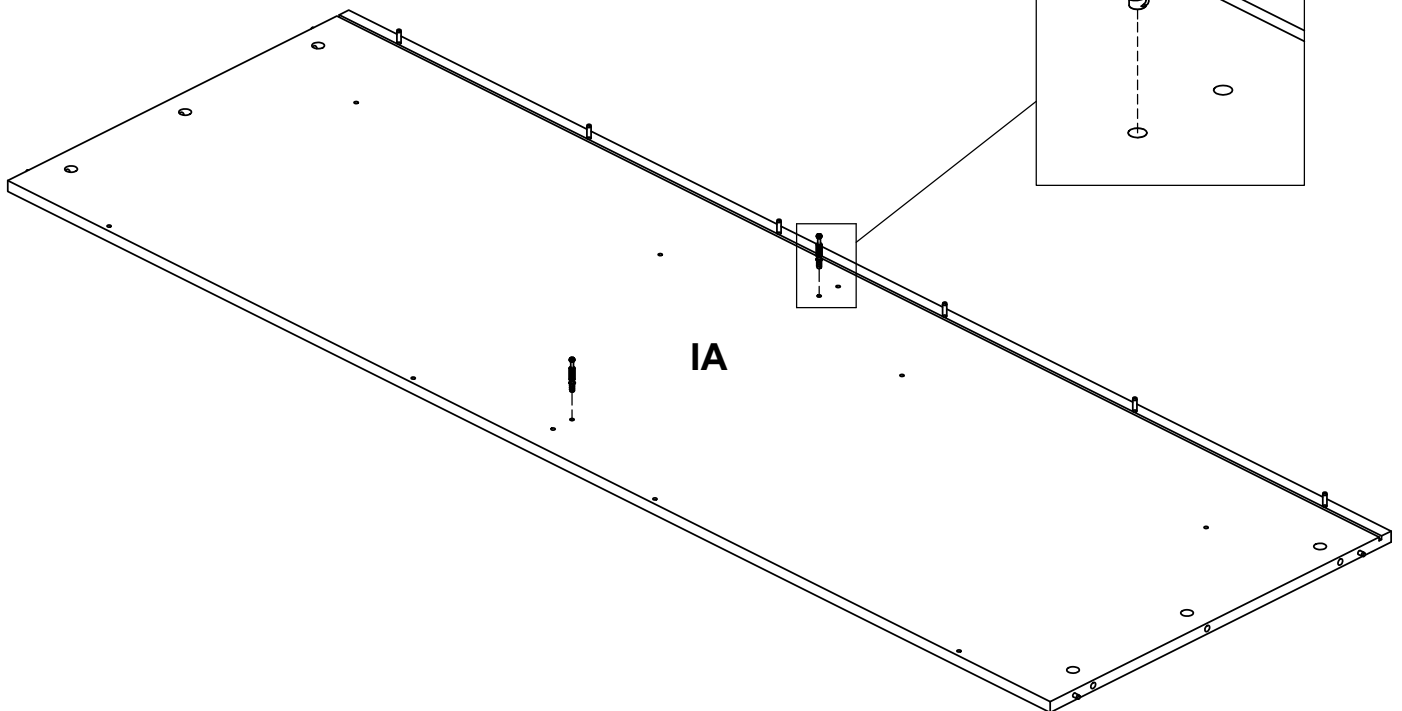
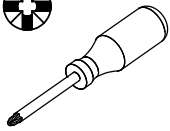

IA

13

0120203

x4

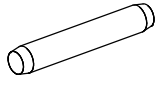

Ø0.2x1.18"
Ø5x30 mm

0163001

x6

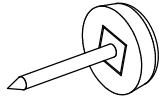

Ø0.47x0.16"
Ø12x4 mm

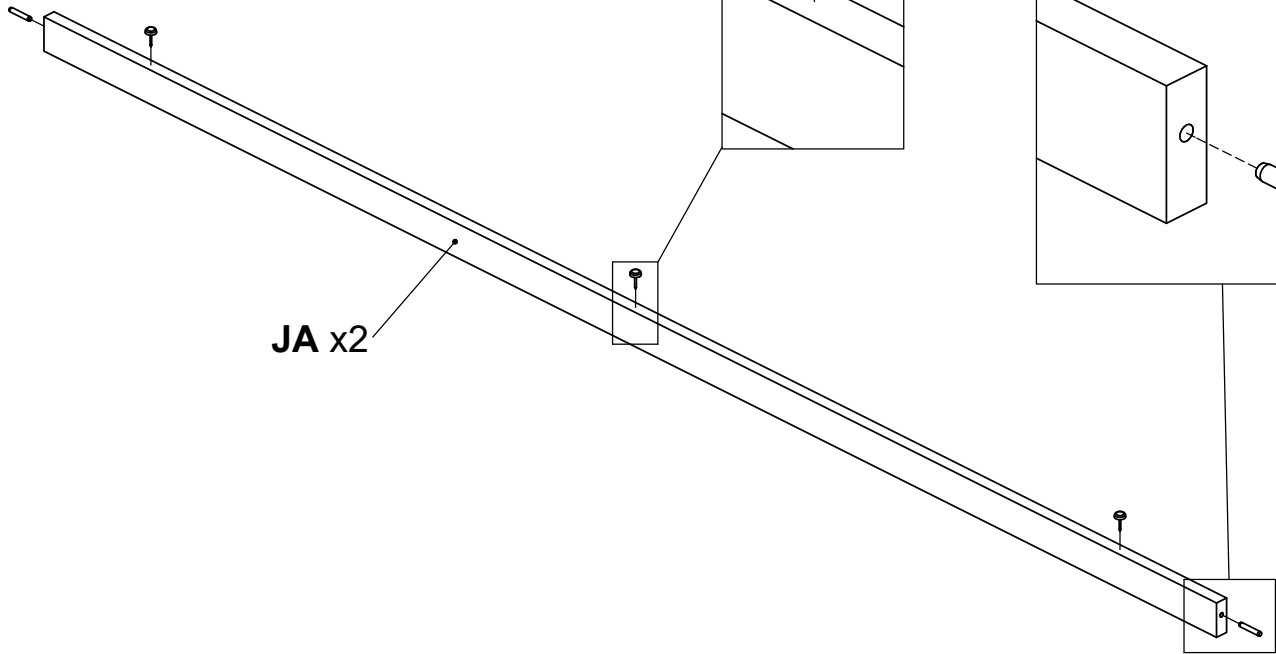
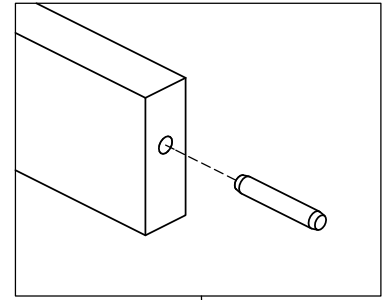
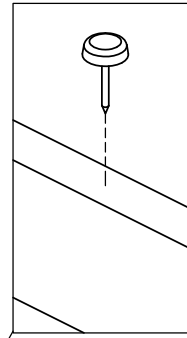
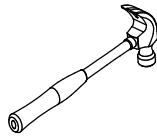

14

0125604

x8

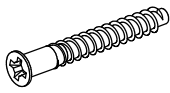

Ø0.2x1.5"
Ø5x38 mm

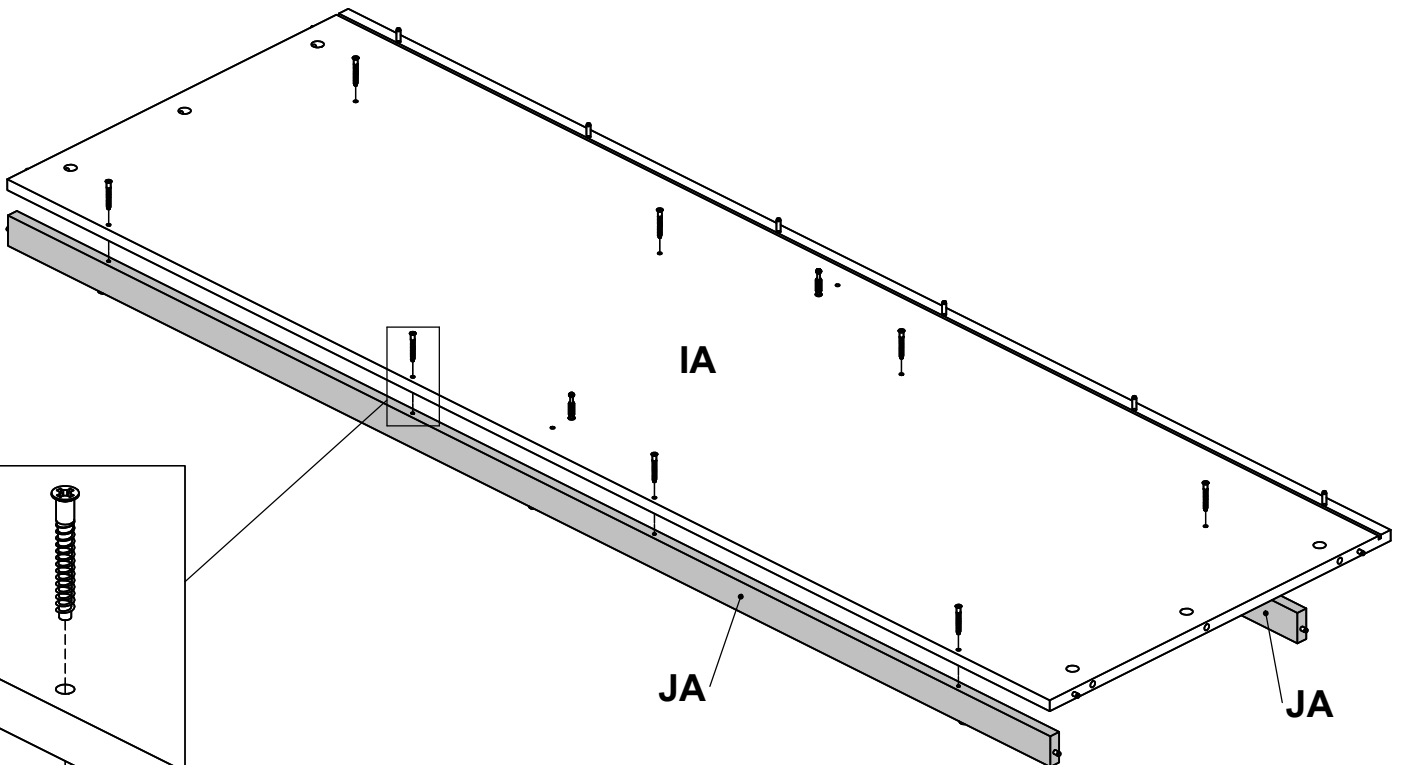
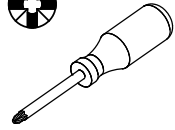

15

0111023

x16

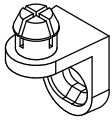

0.93x0.67x0.87"
23.5x17x22 mm

0121607

x16

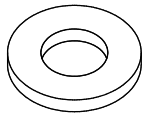

Ø0.79xØ0.39x0.10"
Ø20/Ø10x2,5 mm

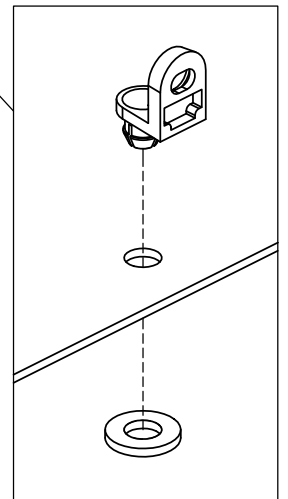
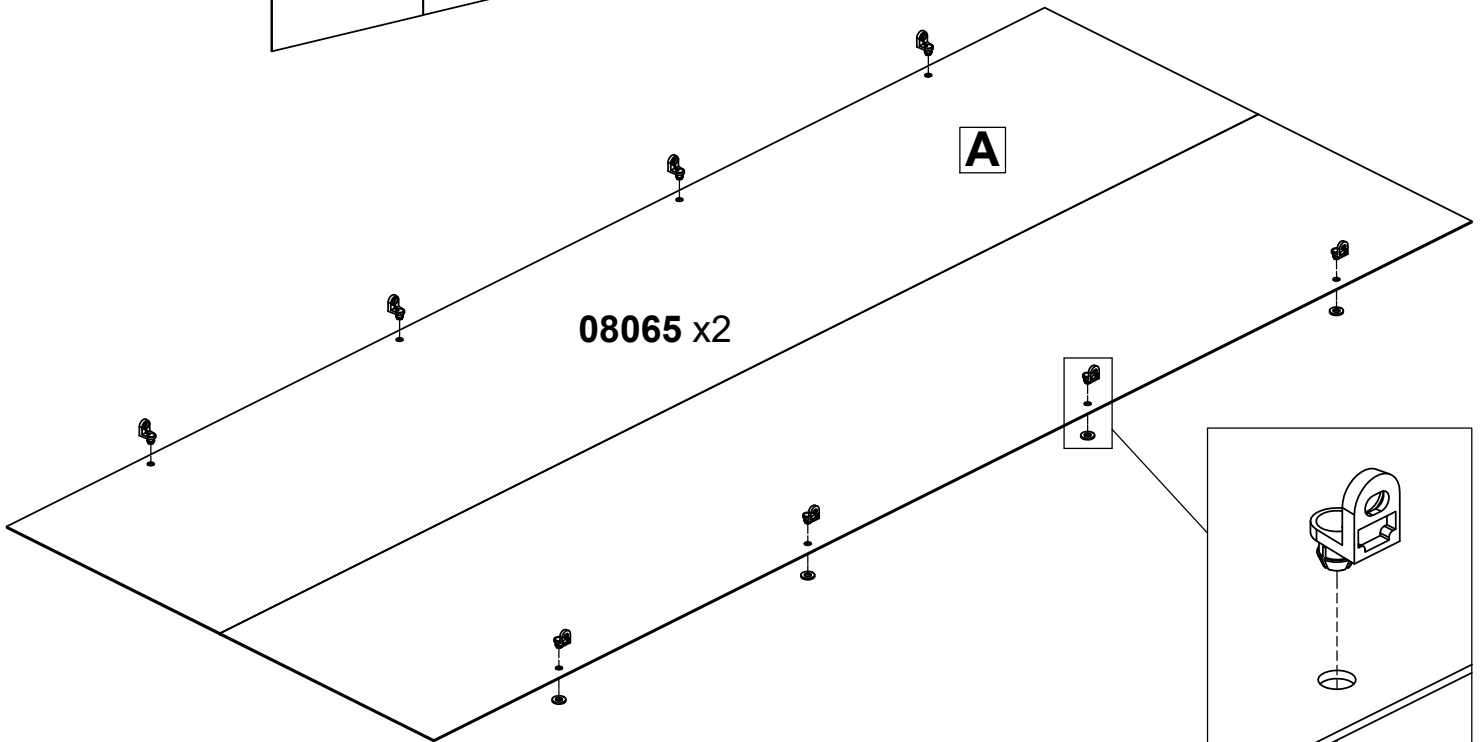
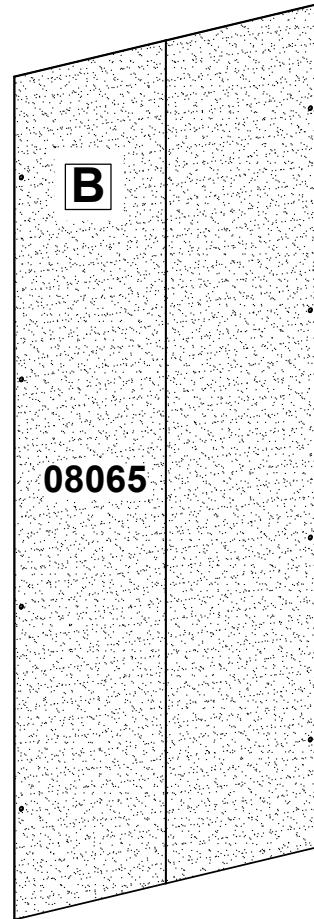
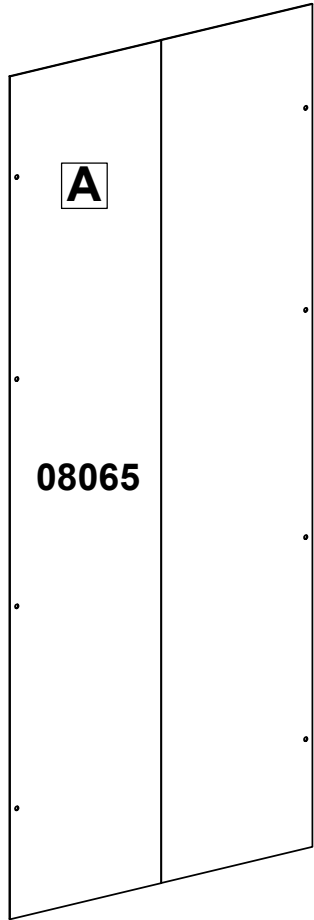

16

0131687

x3

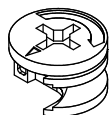

Ø0.59x0.37"
Ø15x9,5 mm

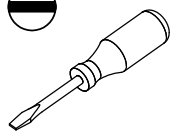

1

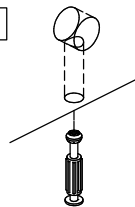

2

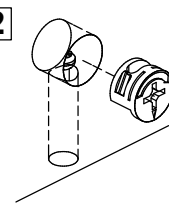

3

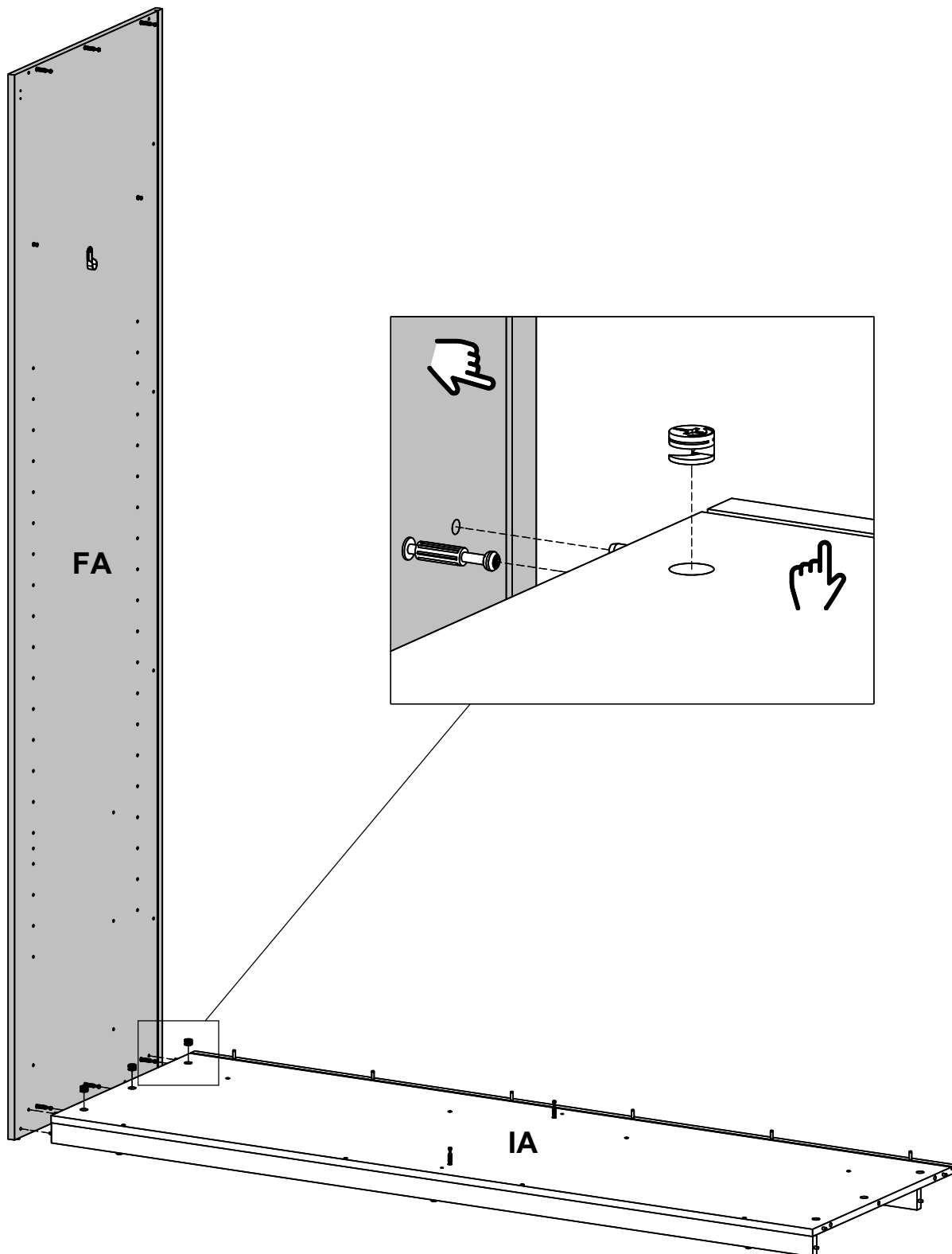
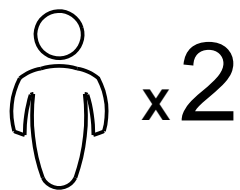
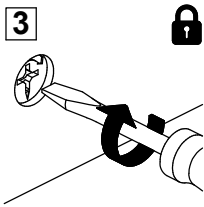

17

0126039

x4

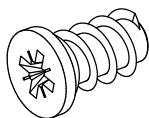

Ø0.25x0.47"
Ø6.3x12 mm

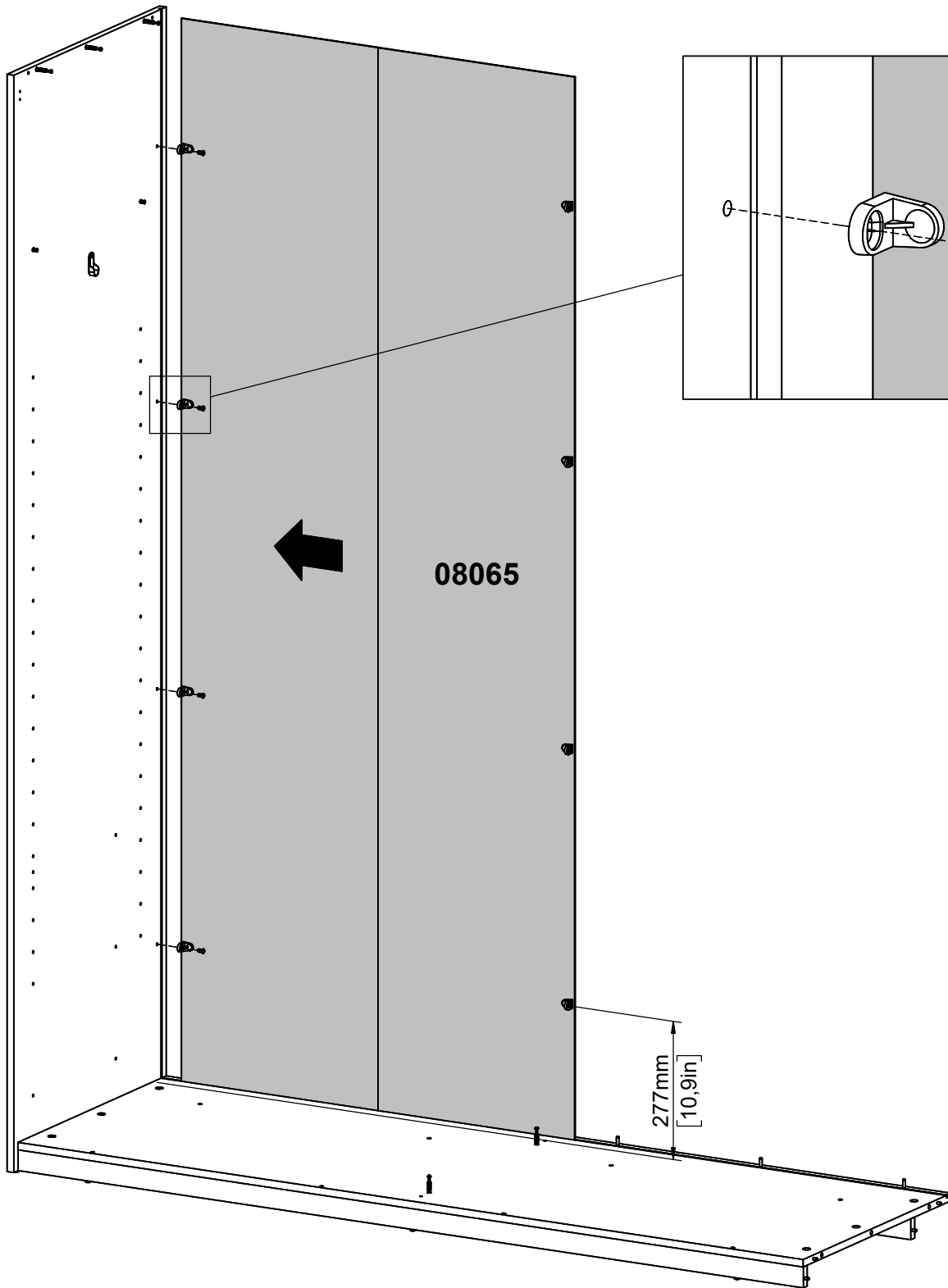
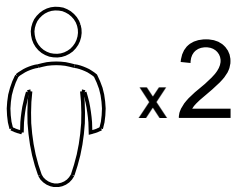
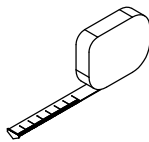
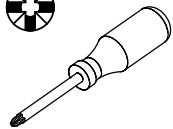

18

0131687

x2

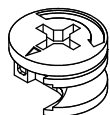

Ø0.59x0.37"
Ø15x9,5 mm

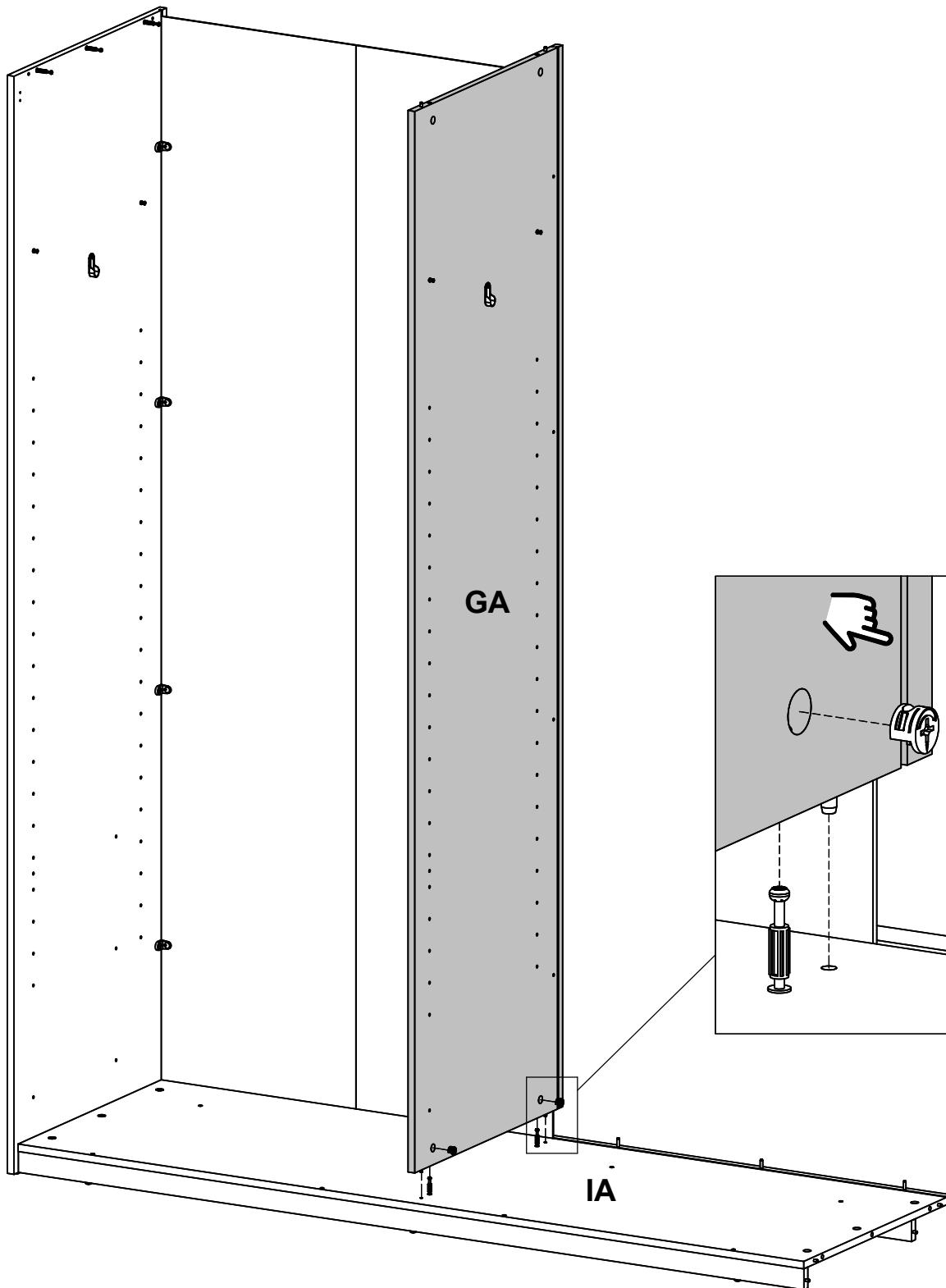
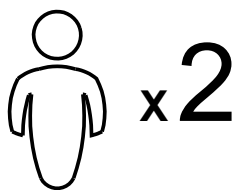
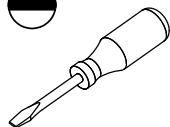

19

0126039

x4

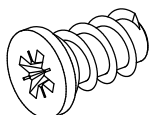

Ø0.25x0.47"
Ø6,3x12 mm

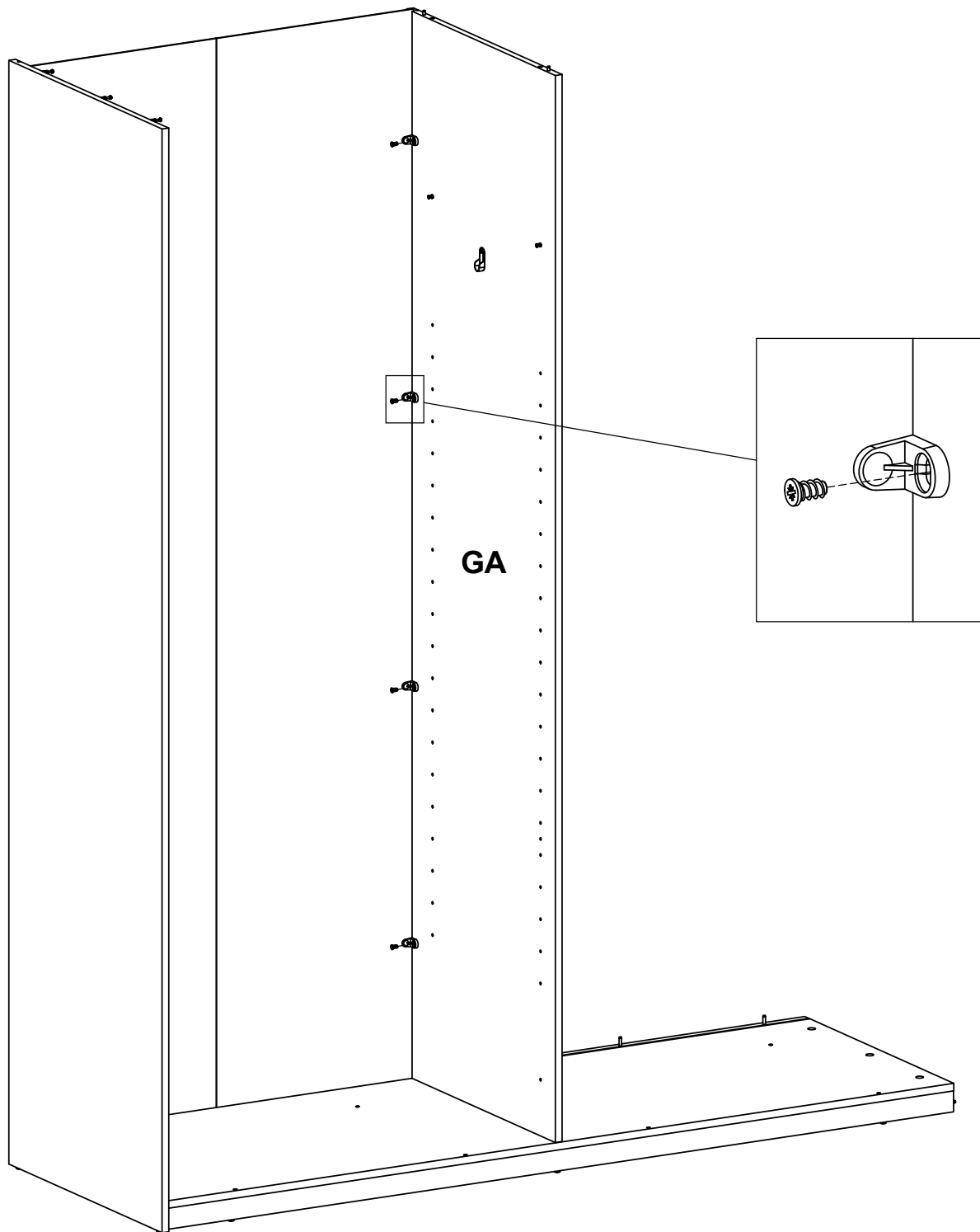
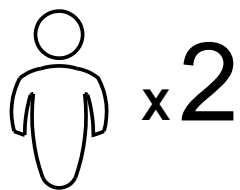
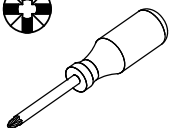

20

0131687

x5

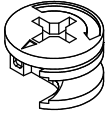

Ø0.59x0.37"
Ø15x9,5 mm

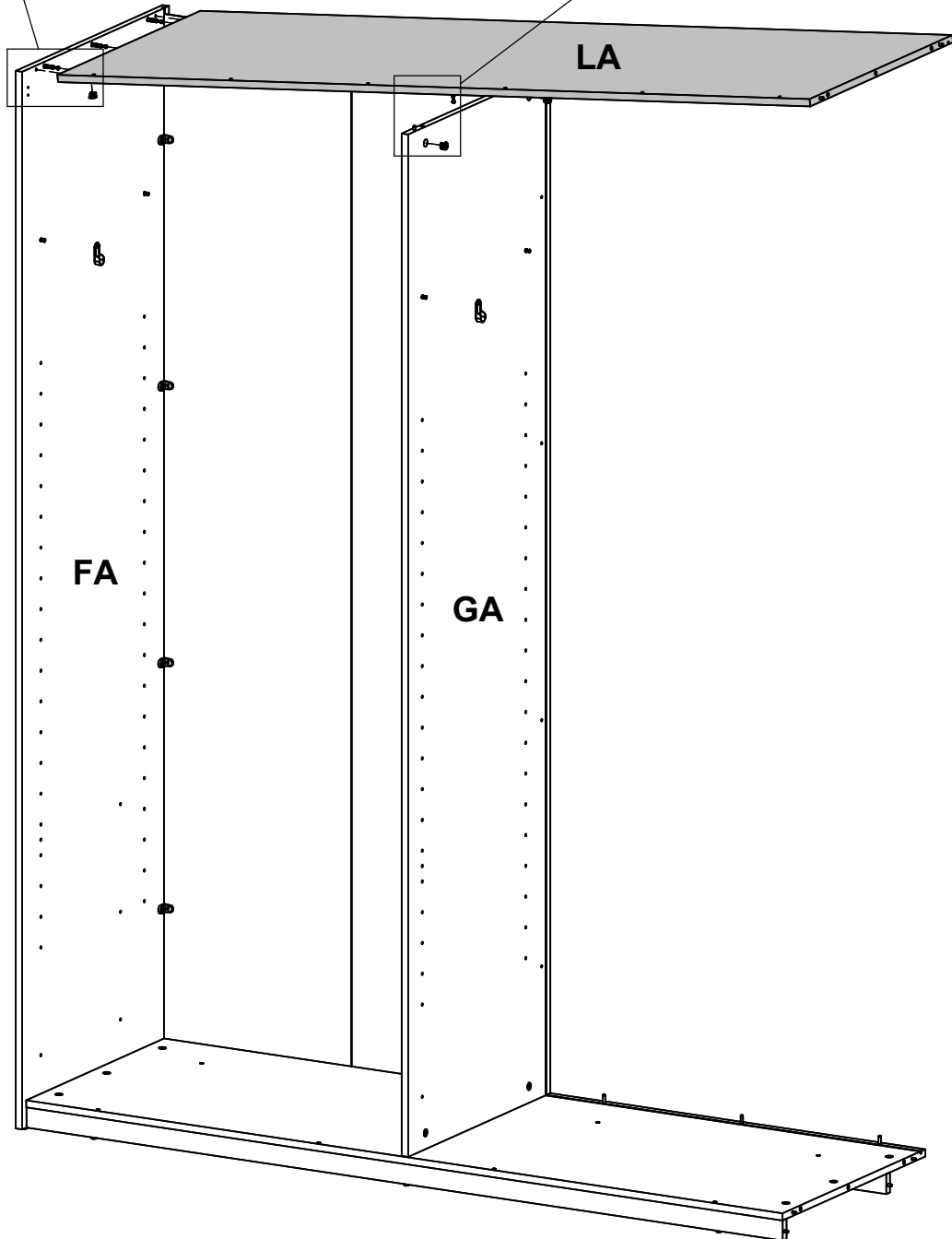
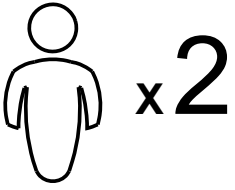
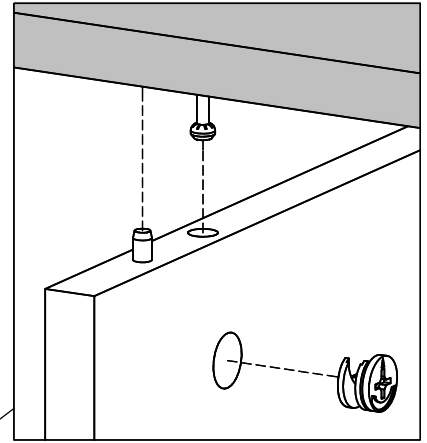
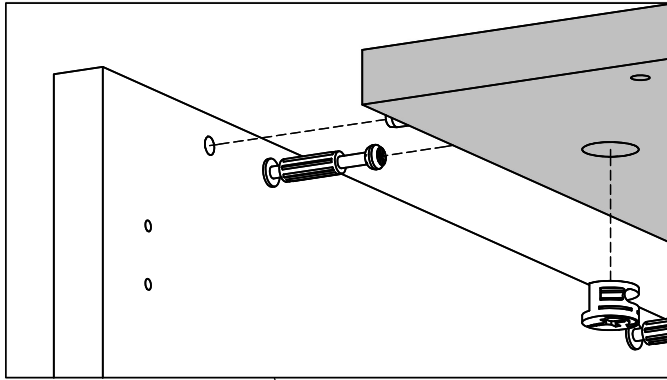
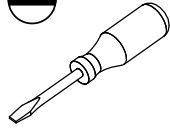

21

0126039

x4

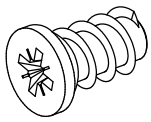

Ø0.25x0.47"
Ø6.3x12 mm

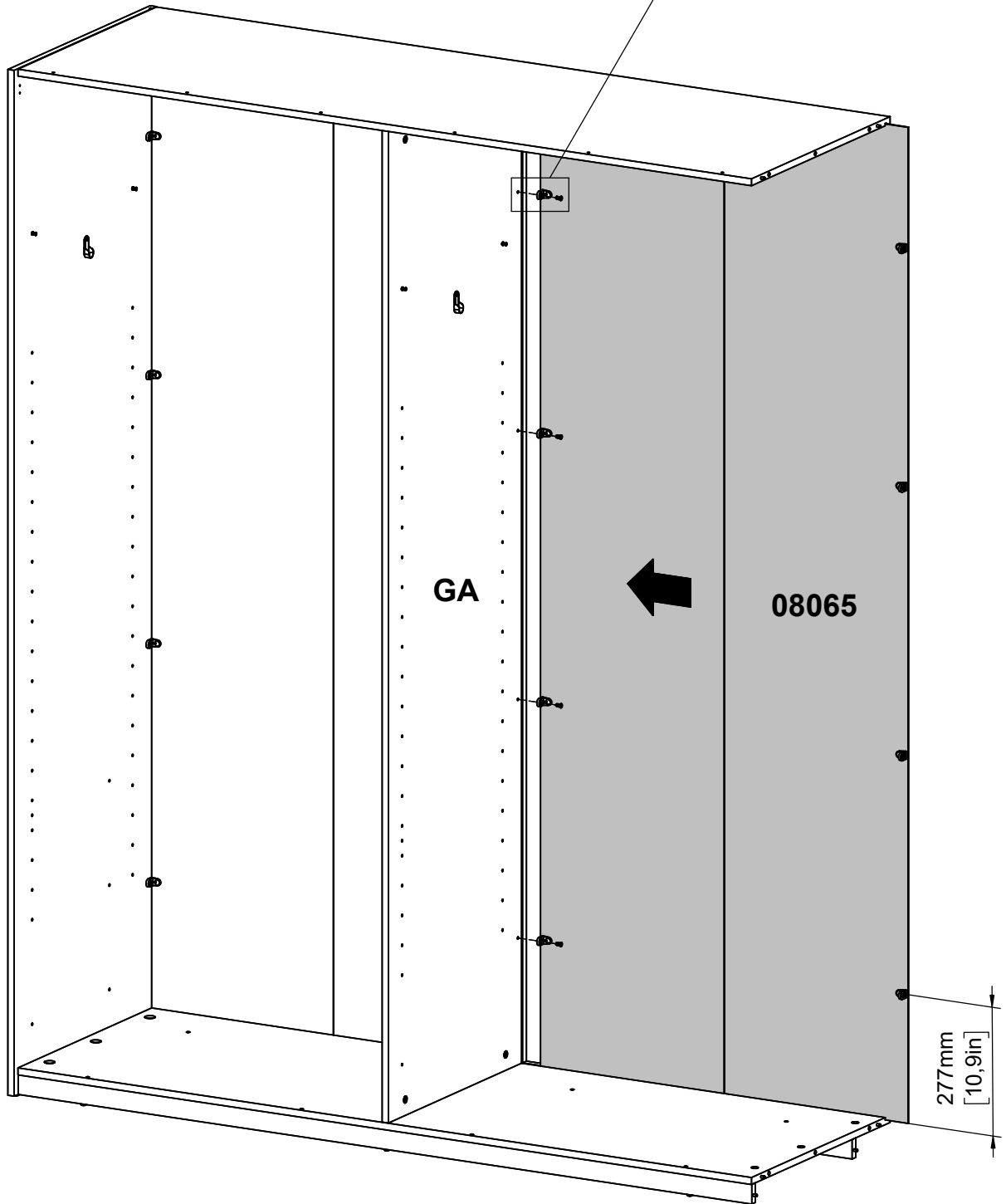
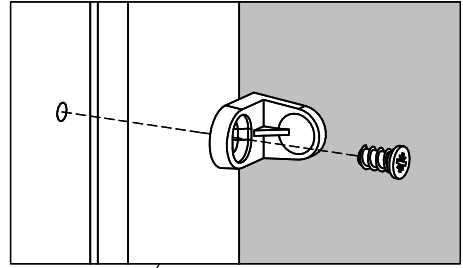
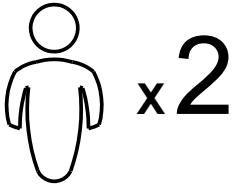
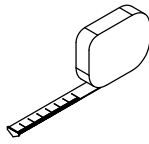
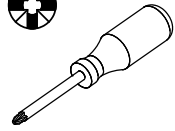

22

0131687

x6

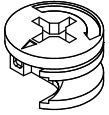

Ø0.59x0.37"
Ø15x9,5 mm

0126039

x4

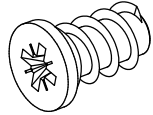

Ø0.25x0.47"
Ø6,3x12 mm

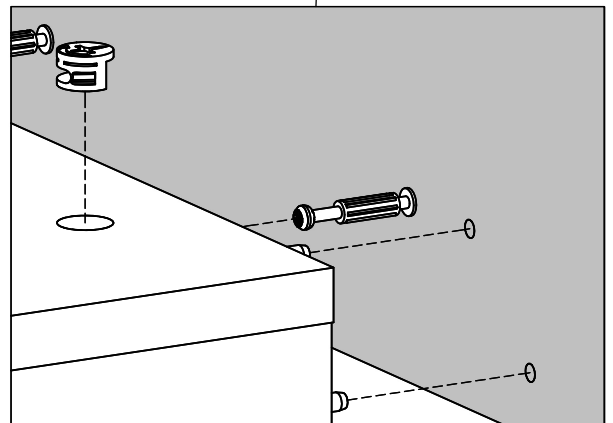
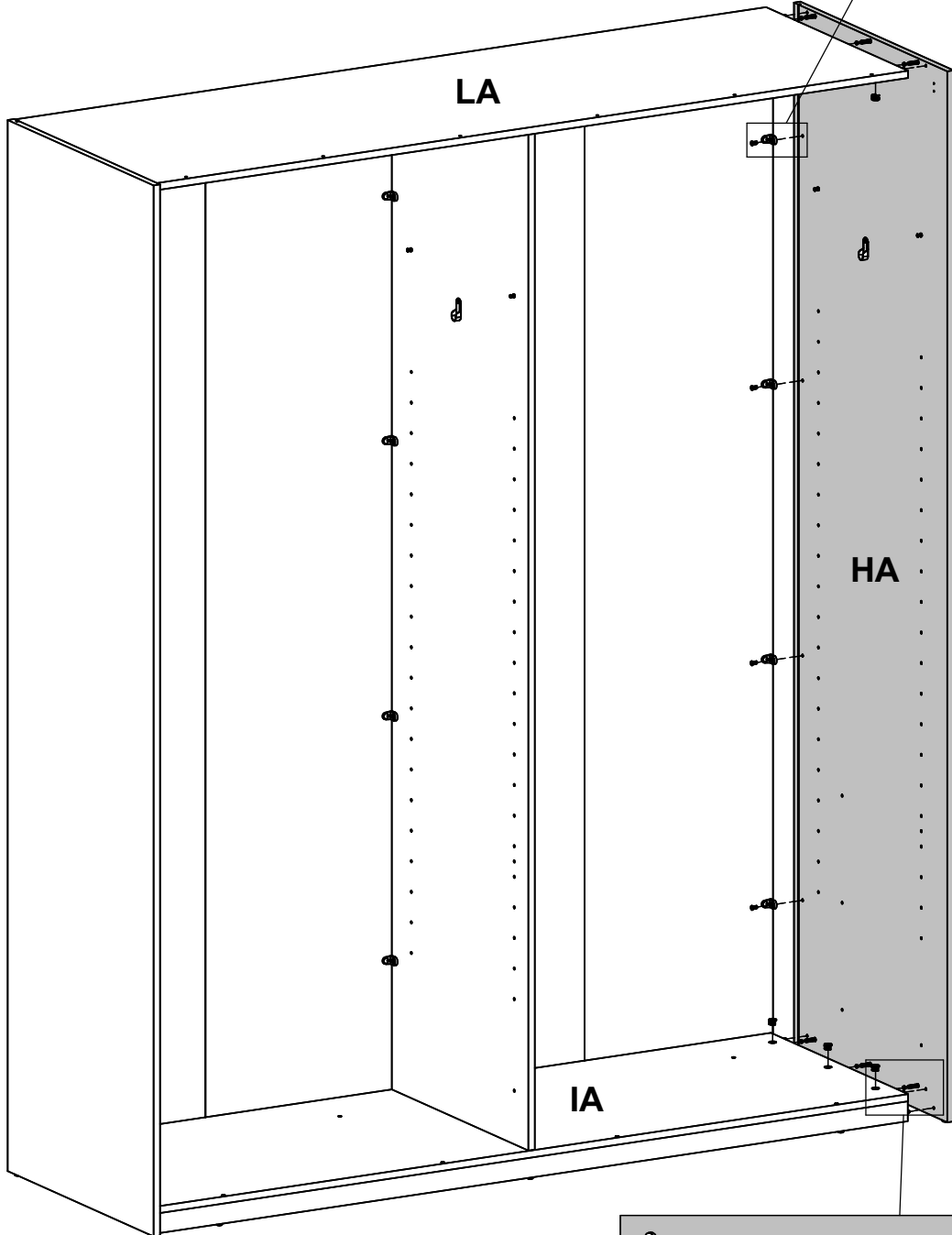
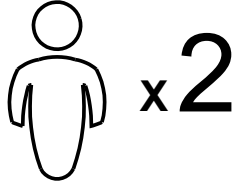
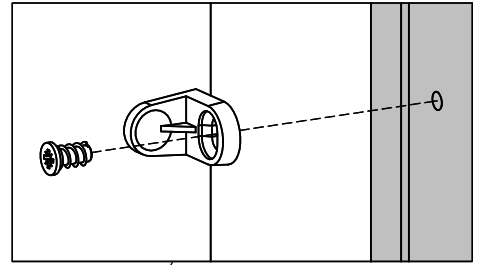
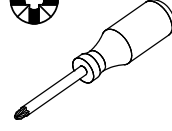
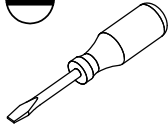

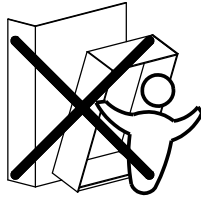
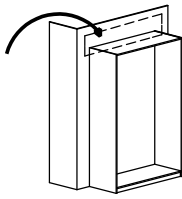

English (en)

IMPORTANT. The screw supplied together with the anti-topple bracket is to be used only for fixing the anti-topple bracket to the furniture. In addition to this, you will need to choose a screw or fitting which is suitable for securing the bracket to the kind of walls you have. If you are unsure about what type of screw to contact your local hardware store.

WARNING: In order to prevent overturning this furniture must be used with the wall attachment device provided. Furniture overturning poses a safety hazard.

Dansk (da)

VIGTIGT! Skruen som følger med væltesikringen er kun til at fæstne væltesikringen i møblet. Du skal derfor supplere med en skrue eller et beslag som passer til det materiale din væg er lavet af. Hvis du er usikker så kontakt din lokale fagmand.

ADVARSEL: For at undgå at møblet tipper skal det anvendes med det medleverede tip-sikrings anordning. Møbler som tipper udgør en sikkerhedsrisiko.

اللغة العربية (ar)

مهم. البرغي المرفق مع القلاب غير القابلة مصمم فقط للاستخدام لتثبيت الكتيفة غير القابلة بالأثاث. بالإضافة إلى ذلك، ستحتاج إلى اختيار برغي أو تركيبية مناسبة لتثبيت الكتيفة بإحكام بنوع الحوائط لديك. إذا كنت غير متأكد من نوع البرغي الذي عليك استخدامه، فقم بالاتصال بمخزن الأجهزة المحلي لديك.

تحذير:

لتفادي انقلاب قطعة الأثاث هذه، يجب استعمالها مع الأداة الواردة الخاصة بالتثبيت في الجدار. فتعاقب الأثاث بشكل خطراً على السلامة.

Bosanski (bs)

Važno: Vijak priložen uz nosač sa zaštitom od prevrtanja je namijenjen samo za pričvršćivanje nosača na namještaj. Uz to bit će potrebno da odaberete vijak ili spojni element pogodan za pričvršćivanje nosača na odgovarajuću vrstu zida. Ako niste sigurni koju vrstu vijka odabrati pitajte u lokalnoj prodavaonici građevinskog materijala.

UPOZORENJE: Da bi se spriječilo prevrtanje ovaj namještaj se mora koristiti sa obezbjeđenom spravom za pričvršćivanje na zid. Prevrtanje namještaja predstavlja sigurnosnu opasnost.

български (bg)

ВАЖНО. Доставеният винт, заедно с репещата скоба, се използва единствено за закрепване на крепящата скоба към ебелите. Освен това Вие ще трябва да изберете винт или фитинг, който е подходящ за закрепване на скобата към вида на Вашите стени. Ако не сте сигурни какъв вид винт да използвате, свържете се с местния магазин за инструменти за дома.

ПРЕДУПРЕЖДЕНИЕ: За да се избегне преобръщане, тази мебел трябва да се използва с предоставения механизъм за закрепване към стената. Преобръщането на мебели представлява заплаха за безопасността.

Català (Cat)

!!! IMPORTANT !!! El cargol que ve inclòs amb el suport antibolcada està destinat al fixar-lo al moble. Heu de fixar l'antibolcada a la paret amb un cargol similar d'acord al material de la paret, consulti el seu ferreter.

ADVERTÈNCIA: Per tal d'evitar que bolqui, cal utilitzar aquest moble amb l'estri subministrat per fixar-lo a la paret. Si el moble bolca pot suposar un perill per a la seguretat.

中文 (zh)

重要提示：

随防倒支架同时提供的螺钉只可用来固定家具的防倒支架。此外，您需要根据墙壁类型 来选择一个合适的螺钉或配件来固定支架。如果您不确定该使用何种螺钉，请咨询当地五金商店。**警告：为了避免家具翻倒，必须使用提供的附壁装置固定家具。家具翻倒会带来安全危险。**

Hrvatski (hr)

VAŽNO Isporučeni vijak i sigurnosni nosač treba upotrijebiti samo za pričvršćivanje sigurnosnog nosača na namještaj. Uz to, morat ćete odabrati vijak ili spojni element prikladan za pričvršćivanje nosača na odgovarajuću vrstu zida. Ako niste sigurni koju vrstu vijka trebate upotrijebiti, pitajte u lokalnoj trgovini željezarijom.

UPOZORENJE: Ovaj se namještaj mora upotrebljavati s isporučenim mehanizmom za pričvršćenje na zid kako bi se spriječilo njegovo prevrtanje. Prevrtanje namještaja opasno je za sigurnost.

Čeština (cs)

DŮLEŽITÍ. Šroub přibalený k bezpečnostnímu kování je určen pouze k přichycení kování k nábytku. Je nutné, zvolit šroub k přichycení kování ke stěně, který je vhodný vzhledem k typu vaší shěny. V případě, kdy si nejste jisti, jaký šroub použít, žádejte o radu v nejbližším obchodě železářství nebo v obchodě domácích potřeb.

VAROVÁNÍ: Aby nedošlo k případnému převrácení nábytku, je nutné použít přiloženou úchytku na zeď. Převrácení nábytku představuje vážné bezpečnostní riziko.

Nederlands (nl)

BELANGRIJK. De schroeven die bij de wandbevestiging zitten, zijn uitsluitend bedoeld om de wandbevestiging aan het meubel te bevestigen. Completeer de wandbevestiging met een schroef of bevestigingsbeslag dat geschikt is voor het materiaal van de wand. Neem bij twijfel contact op met de ijzerhandel.

WAARSCHUWING: Om kantelen van dit meubel te voorkomen, moet het samen met de meegeleverde wandbevestiging worden gebruikt. Het kantelen van meubilair vormt een gevaar voor de veiligheid.

Eesti keeles (et)

TÄHTIS. Ümberkukkumist takistava kronsteiniga koos tarnitud kruvi on mõeldud kasutamiseks ainult ümberkukkumist takistava kronsteini kinnitamiseks mööbli külge. Lisaks sellele peate valima kruvi või kinnituse, mis sobib kronsteini kinnitamiseks sellist tüüpi seinale, nagu teil on. Kui te ei ole kindel, millist kruvi kasutada, pöörduge abi saamiseks kohaliku õõriistakaupluse poole.

HOIATUS: Ümberminemise vältimiseks tuleb kasutada seda mööblit koos komplektis oleva seinakinnitusega. Mööbli ümberminemine võib olla ohtlik.

Suomi (fi)

Huomioi, että turvakiinnikkeen mukana tuleva ruuvi on tarkoitettu ainoastaan kiinnittämään turvakiinnikkeen huonekaluun. Täydennä sen vuoksi ruuvilla tai muulla kiinnityksellä joka sopii seinäsi materiaaliin. Ota yhteyttä tavarataloon, jos olet epävarma.

VAROITUS: Tämän huonekalun kaatuminen on estettävä käyttämällä sen mukana toimitettua seinäkiinnikettä. Huonekalun kaatuminen aiheuttaa turvallisuusriskin.

Français (fr)

IMPORTANT : la vis fournie avec le dispositif anti-bascule est destinée à fixer le dispositif dans le meuble. Pour la fixation au mur, compléter par une vis adaptée au support mural. En cas de doute, contacter un magasin de bricolage.

AVERTISSEMENT : afin d'empêcher tout basculement, ce mobilier doit être utilisé avec le dispositif de fixation au mur fourni. Le basculement du mobilier constitue un risque pour la sécurité.

Deutsch (de)

WICHTIG. Die dem Kippschutz beigefügten Schrauben sind ausschließlich für die Befestigung des Kippschutzes am Möbelstück vorgesehen. Für die Befestigung des Kippschutzes an der Wand benötigen Sie zusätzlich Schrauben oder Beschläge, die zur Beschaffenheit der Wand passen. Falls Sie nicht sicher sind, welche Art von Schrauben geeignet sind, wenden Sie sich bitte an den Fachhandel.

WARNHINWEIS: Um das Umkippen dieses Möbelstücks zu verhindern, muss die mitgelieferte Wandbefestigung verwendet werden. Umkippende Möbelstücke stellen ein Sicherheitsrisiko dar.

Ελληνικά (el)

ΣΗΜΑΝΤΙΚΟ. Η βίδα που παρέχεται μαζί με το αντιανατρεπτικό στηρίγμα πρέπει να χρησιμοποιηθεί μόνο για τη στερέωση του αντιανατρεπτικού στηρίγματος στο έπιπλο. Εκτός από αυτή τη βίδα, θα χρειαστείτε μία βίδα ή εξάρτημα που είναι κατάλληλο για τη στερέωση του στηρίγματος στο είδος του τοίχου που έχετε. Εάν δεν είστε σίγουροι για τον τύπο της βίδας που πρέπει να χρησιμοποιήσετε, επικοινωνήστε με ένα σιδηροπωλείο.

ΠΡΟΕΙΔΟΠΟΙΗΣΗ: Για την αποφυγή ανατροπής, το έπιπλο πρέπει να χρησιμοποιείται με τη συσκευή προσάρτησης στον τοίχο που παρέχεται. Η ανατροπή επίπλων συνιστά κίνδυνο ασφαλείας.

Magyar (hu)

FONTOS. A dőlést megakadályozó tartóhoz kapott csavar kizárólag a tartó bútorhoz történő rögzítéséhez használható. Ezen felül ki kell választania, hogy milyen csavart vagy szerelvényt használjon ahhoz a falhoz, ahova a tartókart rögzíteni szeretné. Amennyiben nem biztos benne, hogy milyen csavart kell használnia, lépjen kapcsolatba a helyi vasárbolttal.

FIGYELMEZTETÉS: A bútor a felborulás megelőzése érdekében a mellékelt fali rögzítővel kell használni. A bútor felborulása biztonsági veszélyt jelent.

Italiano (it)

IMPORTANTE. Le viti che vengono fornite insieme al dispositivo antiribaltamento vanno utilizzate soltanto per fissare questo dispositivo al mobile. Scegli quindi le viti o il dispositivo di fissaggio che più si adattano alle pareti di casa tua. In caso di dubbi contatta il tuo ferramenta.

AVVERTENZE Applicare il dispositivo di fissaggio a parete fornito in dotazione per evitare il ribaltamento del mobile. Il ribaltamento del mobile costituisce un rischio per la sicurezza.

日本語 (ja)

重要 ぐらつき防止用ブラケットに同梱されているネジは、ぐらつき防止用ブラケットを家具に取り付けるための専用ネジです。また、ブラケットを取り付けるには、ご使用の壁の種類に応じて、適切なネジまたは取付金具を選ぶ必要があります。使用するネジの種類が分からない場合は、お近くの金物店までお問い合わせください。警告: この家具が転倒しないようにするために、必ず付属の壁に固定する装置を使用してください。家具の転倒は、大変危険です。

Latviski (lv)

SVARĪGI. Skrūve, kas tiek iekļauta pretapgāšanās kronšteina komplektācijā, ir izmantojama tikai, lai piestiprinātu pretapgāšanās kronšteinu pie mēbeles. Papildus arī jums ir jāizvēlas skrūve vai stiprinājums, kas ir piemērots kronšteina fiksēšanai pie jūsu telpās esošā sienu veida. Ja neesat pārliecināti

par to, kāda tipa skrūves lietot, sazinieties ar vietējo būvmateriālu veikalu.

BRĪDINĀJUMS! Lai mēbeles neapgāztos, tās jāizmanto kopā ar komplektācijā iekļautajiem sienas stiprinājumiem. Mēbeļu apgāšanās rada draudus drošībai.

Lietuvių (lt)

SVARBU. Kartu su laikikliu nuo apsvirtimo tiekiamas sraigtas turi būti naudojamas tik laikikliui nuo apsvirtimo tvirtinti prie baldų. Taip pat jums reikės pasirinkti sraig tą arba tvirtinimo elementą, tinkantį laikikliui tvirtinti prie jūsų kambario sienos. Jeigu nežinote, kokio tipo sraig tą pasirinkti, kreipkitės į vietos statybinių prekių parduotuvę.

ĮSPĖJIMAS: Kad baldas neapvirtų, jis turi būti naudojamas su pridėdamu tvirtinimo prie sienos prietaisu. Galintis apvirtti baldas kelia pavojų saugai.

Norsk (no)

VIKTIG. Legg merke til at skruen som følger med tippebeskyttelsen kun skal brukes for å feste tippebeskyttelsen i møbelet. Kompletter derfor med en skrue eller et feslebeslag tilpasset materialet i veggen din. Er du usikker, ta kontakt med din lokale fagforhandler.

ADVARSSEL: Det medfølgende veggfestet må brukes for å hindre at møbelet velter. Hvis møbelet velter, kan det medføre sikkerhetsrisiko.

Polski (pl)

UWAGA! W komplecie z mocowaniami zapobiegającymi wywróceniu mebla są śruby, które służą tylko do przytwierdzenia ich do mebla. Rodzaj śrub przytwierdzających je do ściany zależy od rodzaju materiału z jakiego została wykonana (gips, cegła, drewno itd.). Będą więc potrzebne dodatkowo odpowiednie śruby. Jeśli masz wątpliwości co do rodzaju śrub zasięgnij opinii fachowca.

OSTRZEŻENIE: Aby zapobiec przewróceniu się, meble należy unieruchomić za pomocą dołączonego mocowania ściennego. Przewrócenie się mebli stwarza zagrożenie dla bezpieczeństwa.

Português (pt)

MUITO IMPORTANTE. O parafuso fornecido junto com o dispositivo anti-queda deve ser usado unicamente para para fixar o dispositivo anti-queda ao móvel. Deve também escolher um parafuso ou fixação que seja adequada para segurar o dispositivo ao tipo de paredes que tiver. Se não tiver a certeza de que tipo de parafuso deve usar, deve dirigir-se a uma loja especializada.

AVERTÊNCIA: De modo a evitar que esta peça de mobiliário se vire ao contrário, esta deve ser usada com o dispositivo de fixação à parede. O derrube da mobília constitui um perigo para a segurança.

Română (ro)

IMPORTANT. Șurubul furnizat împreună cu consola anti-răsturnare va fi utilizat doar pentru fixarea consolei anti-răsturnare pe mobilă. Pe lângă aceasta, va trebui să alegeți un șurub sau montură adecvată pentru fixarea consolei pe tipul de perete din încăperea respectivă. Dacă aveți nelămuriri privind tipul de șurub de utilizat contactați magazinul local de scule și unelte. **AVERTISMENT: pentru a preveni răsturnarea, această piesă de mobilier va fi utilizată cu dispozitivul furnizat pentru prinderea de perete. Răsturnarea mobilei reprezintă un pericol pentru siguranță.**

Русский (ru)

ВАЖНО. Болт, поставляемый вместе с держателем против опрокидывания, должен использоваться только для крепления данного держателя к мебели. В дополнение к этому необходимо подобрать шуруп или крепление для фиксации держателя на стене в зависимости от ее типа. Если

вы не уверены, какой шуруп использовать, обратитесь за консультацией в местный магазин строительных товаров.

ПРЕДУПРЕЖДЕНИЕ. Во избежание опрокидывания мебели следует использовать предоставленное настенное крепление. Опрокидывание мебели влечет опасность травмирования.

Srpski (sr)

Važno: Ovaj zavrtnaj, koji se isporučuje zajedno sa sigurnosnim nosačem, treba koristiti samo za pričvršćivanje sigurnosnog nosača na nameštaj. Pored toga, treba da izaberete odgovarajući zavrtnaj ili spojni element za pričvršćivanje nosača na odgovarajuću vrstu zida. Ako niste sigurni koju vrstu zavrtnja da upotrebite, obratite se lokalnom gvožđaru.

UPOZORENJE: Da bi se sprečilo prevrtanje, ovaj nameštaj mora da se koristi sa priloženim sredstvom za pričvršćivanje za zid. Prevrtanje nameštaja predstavlja bezbednosni rizik.

Slovenčina (sk)

DŔLEŽITÉ UPOZORNENIE. Skrutka dodávaná spolu s ezpečnostným kovaním je určena iba na upevnenie kovania k nábytku. okrem toho budete potrebovať skrutku za prichytenie kovania k stene. Túto si vyberte podľa druhu steny. AK si nie ste istý, aký, druh skrutky potrebujete, kontaktujte najbližšie železiarstvo.

VAROVANIE: Aby nedošlo k prípadnému prevráteniu nábytku, je nutné použiť priloženú príchytku na stenu. Prevrátenie nábytku predstavuje vážne bezpečnostné riziko.

Slovenščina (sl)

POMEMBNO Priloženi vijak, skupaj z nosilcem za pritrditev proti prevrnitvi, je namenjen izključno pritrditvi nosilca za pritrditev proti prevrnitvi na pohištvo. Poleg tega boste potrebovali tudi ustrezen vijak oz. element za pritrdjevanje nosilca na vaš tip stene. Če niste prepričani o tem, kakšen vijak je najprimernejši, se obrnite na eno od tehničnih trgovin v vaši bližini.

OPOZORILO: Da bi preprečili prevračanje, morate to pohištvo uporabiti s priloženo napravo za pritrditev na steno. Prevračanje pohištva predstavlja nevarnost.

Español (es)

¡¡IMPORTANTE! El tornillo que viene incluido con el soporte antivuelco está destinado a fijarlo en el mueble. Debes fijar el antivuelco en la pared con un tornillo o similar de un tipo acorde con el material de esta. Consulta con tu ferretería. **ADVERTENCIA: Con el fin de evitar que el mueble vuelque, debe utilizarse siempre con el dispositivo de fijación de pared facilitado. El mobiliario que puede volcar representa un peligro para la seguridad*.**

Svenska (sv)

Observera att skruven som medföljer tippskyddet endast är avsedd för att fästa tippskyddet i möbelen. Komplettera därför med en skruv eller ett fastbeslag som passar materialet i din vägg. Är du osäker kontakta din lokala fackhandel.

VARNING: Denna möbel måste användas tillsammans med den medföljande anordningen för väggfäste för att förhindra att möbelen välter. Vältande möbler utgör en säkerhetsrisk.

Türkçe (tr)

ÖNEMLİ. Devrilmeyi önleyen destek ile birlikte verilen vida, yalnızca devrilmeyi önleyen desteği mobilyaya monte etmek için kullanılacaktır. Buna ek olarak, desteği sahip olduğunuz duvar türüne monte etmeniz için uygun bir vida veya bağlantı elemanı seçmeniz de gerekecek. Eğer hangi tür vida kullanacağımızdan emin değilseniz yerel hırdavatçınıza başvurun.

UYARI: Aşırı dönmesini önlemek için bu mobilya verilen duvar bağlantı parçası ile birlikte kullanılmalıdır. Mobilyanın aşırı dönmesi güvenlik riski oluşturur.

Українська (uk)

Важливо: Болт, який постачається разом з тримачем від перекидання, повинен використовуватися тільки для кріплення цього тримача до меблів. Крім цього, необхідно підібрати шуруп або кріплення для фіксації тримача на стіні, залежно від її типу. Якщо ви не впевнені, який шуруп використовувати, зверніться за консультацією до місцевого магазину будівельних товарів.

УВАГА! Ці меблі потрібно використовувати з пристроєм для настінного кріплення, який надається в комплекті, щоб запобігти їхньому перевертання. У разі перевертання меблів може виникати загроза безпеці.

23

0113451

x2

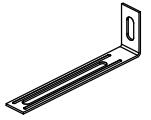

1.22x3.98x0.59x0.05"
31x101x15x1,3 mm

0125440

x4

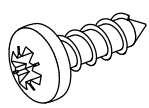

Ø0.16x0.51"
Ø4x13 mm

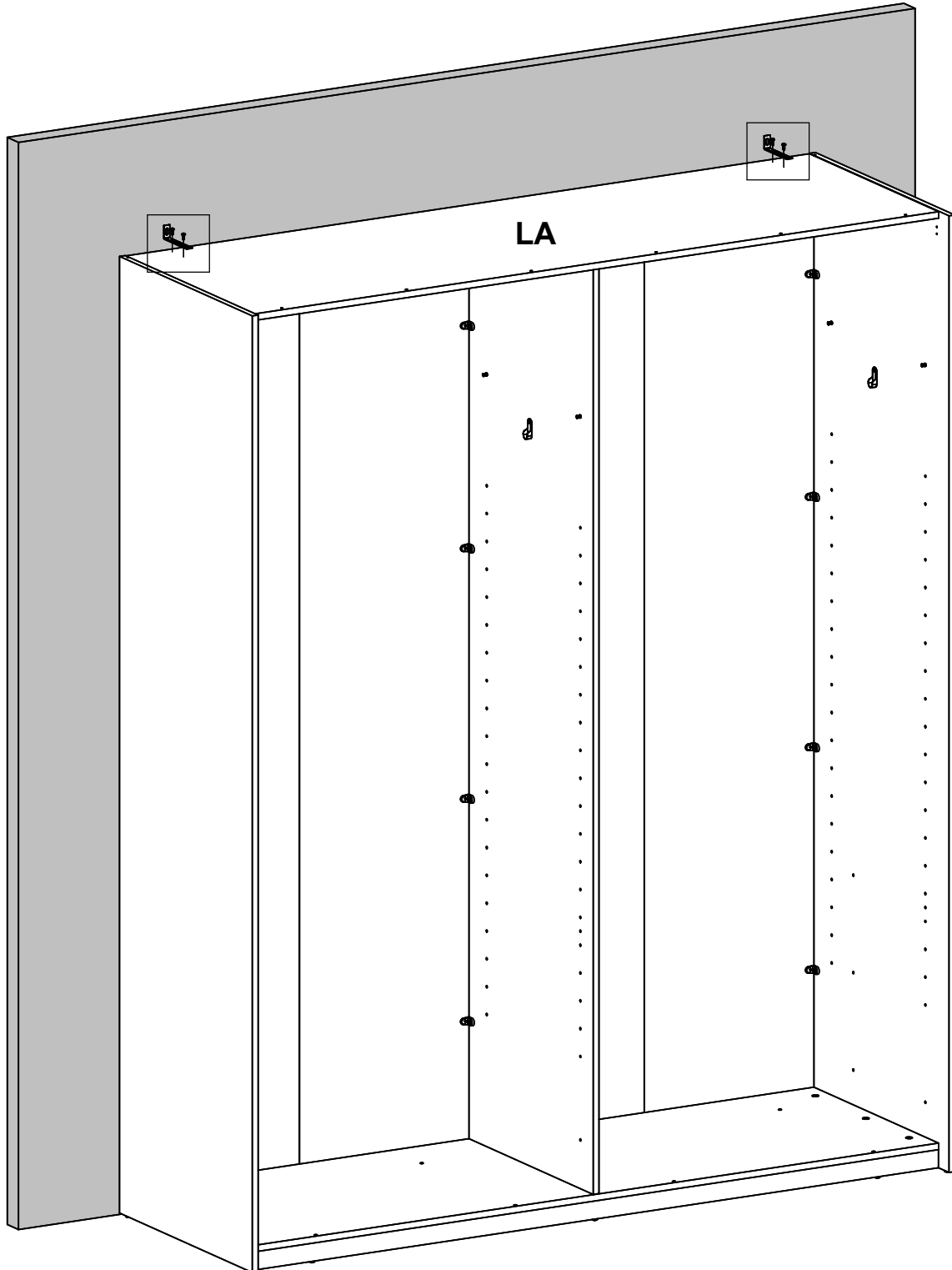
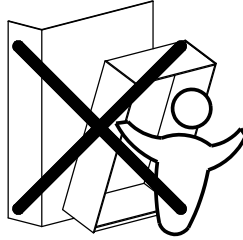
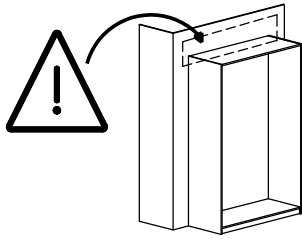
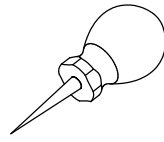
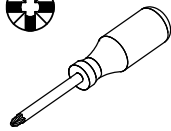

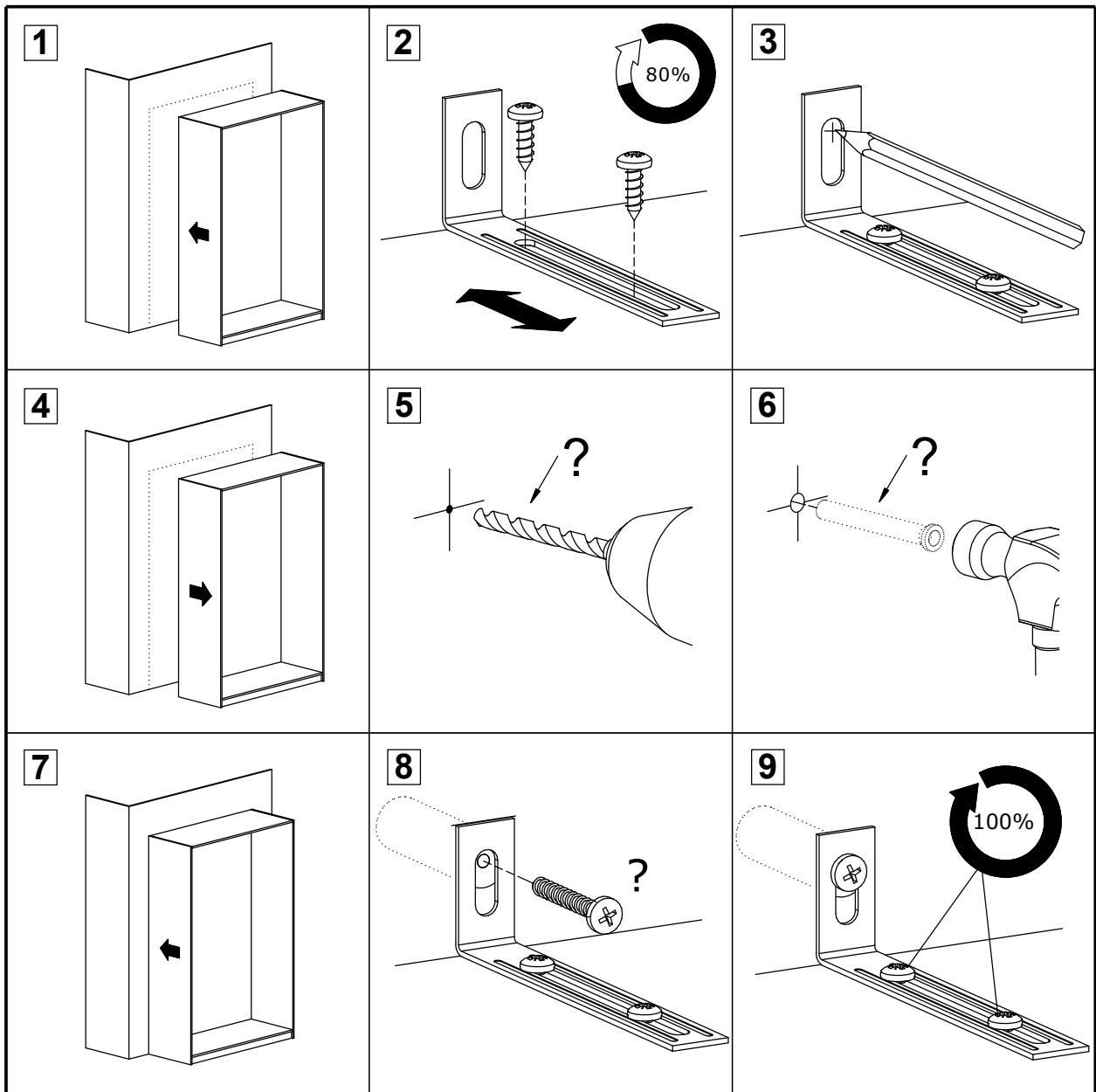
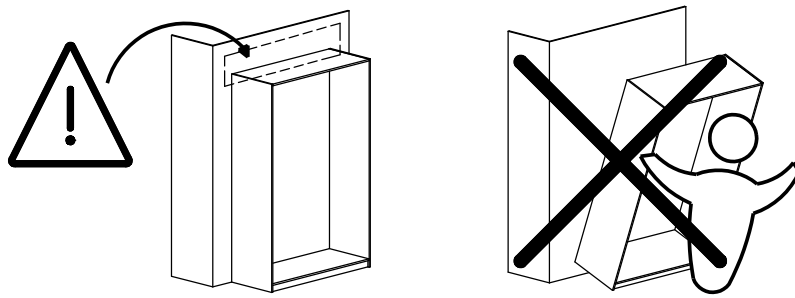

24

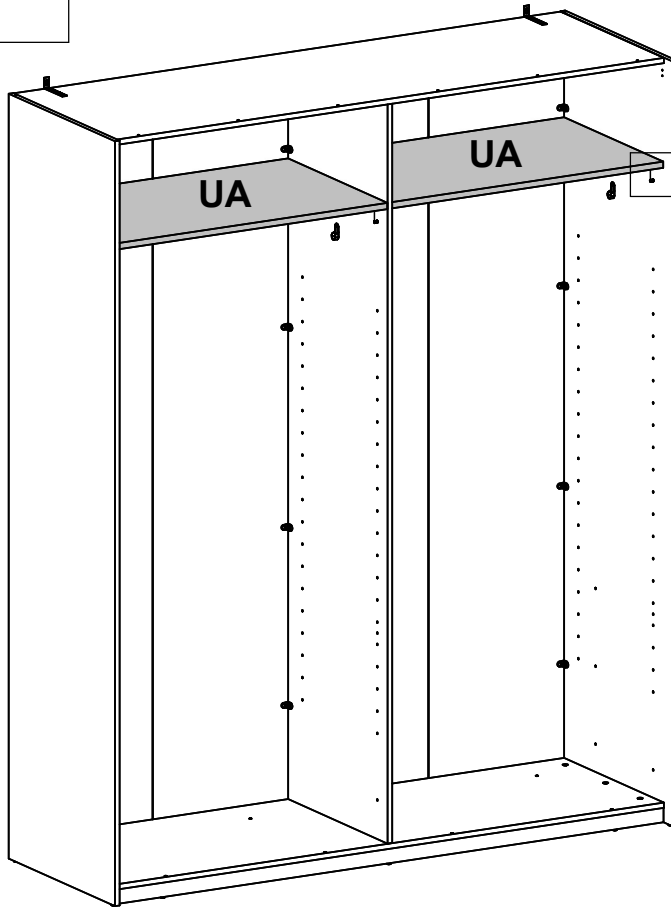
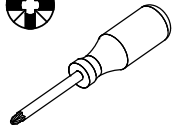

1

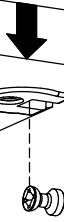

2



25

0172585

x2

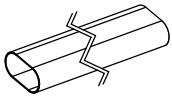

34.06x0.59x1.12"
865x15x28.5 mm

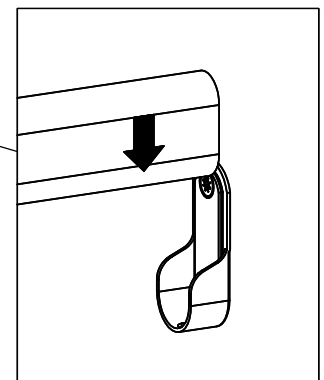
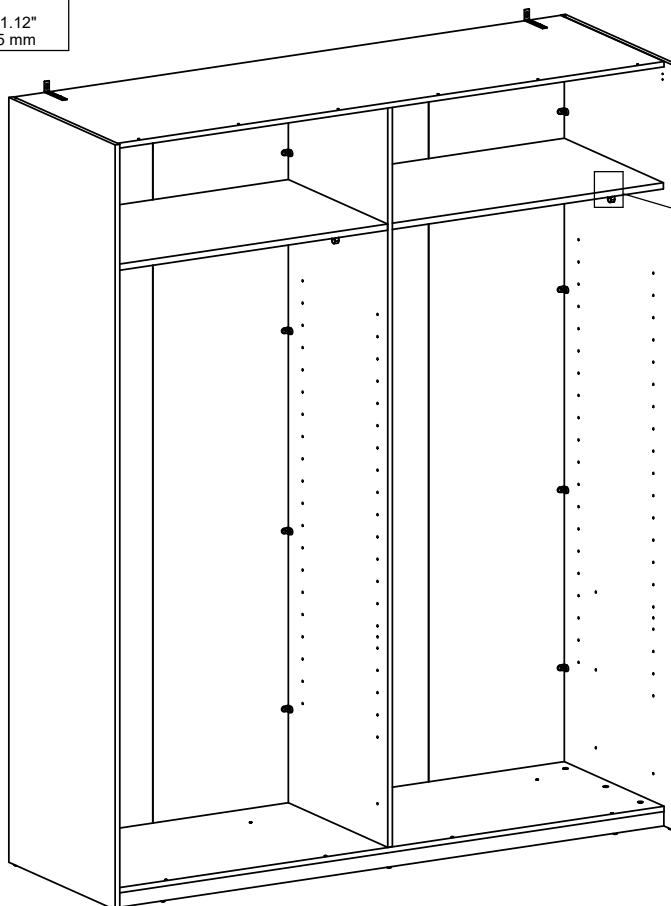

26

0110901

x16



Ø0.87x0.02"
Ø22x0.5 mm

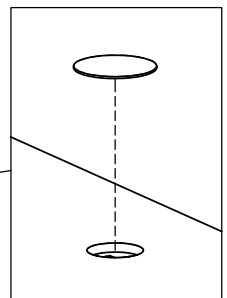
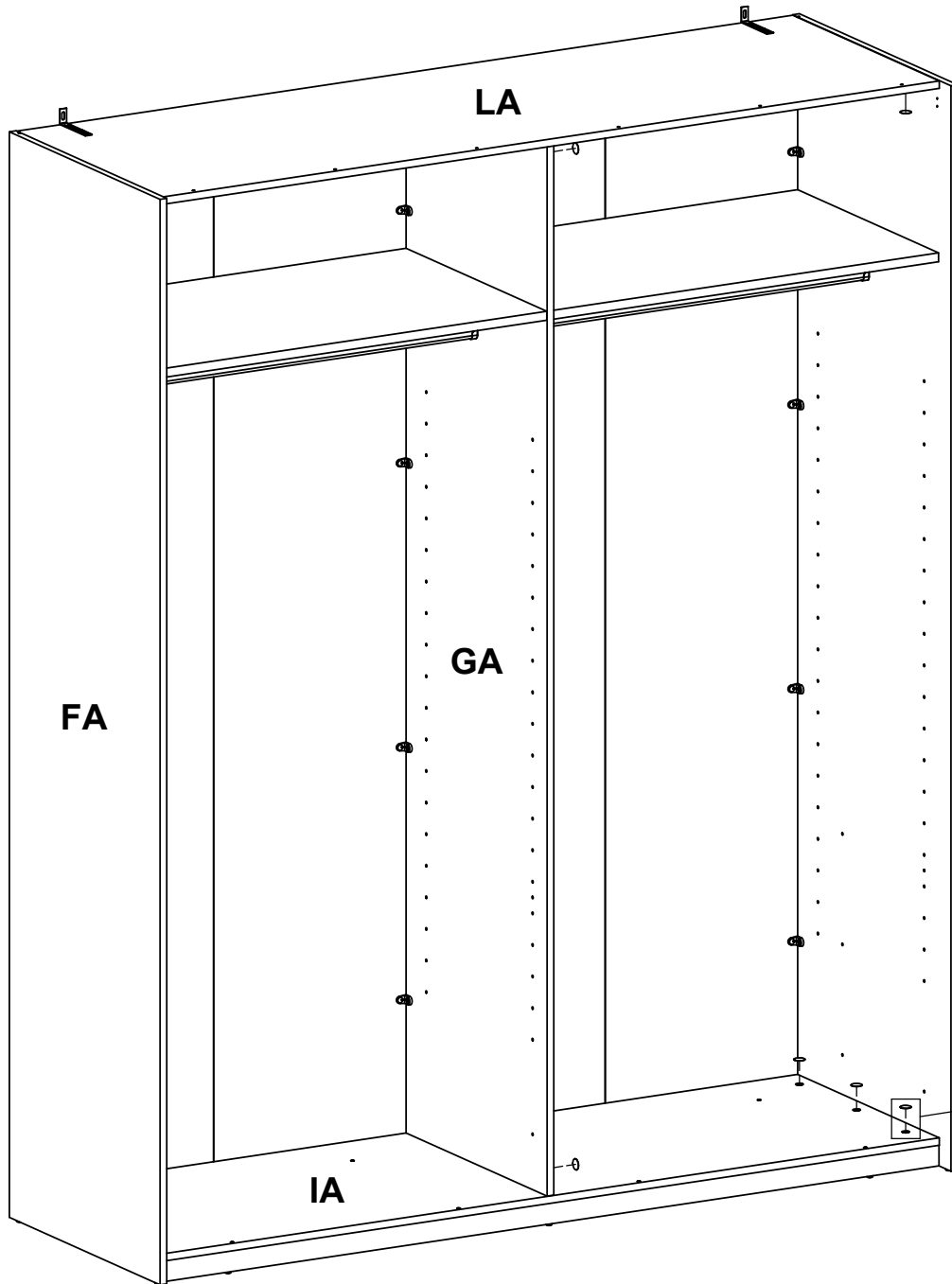

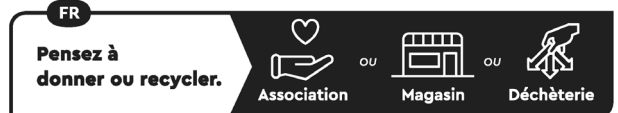
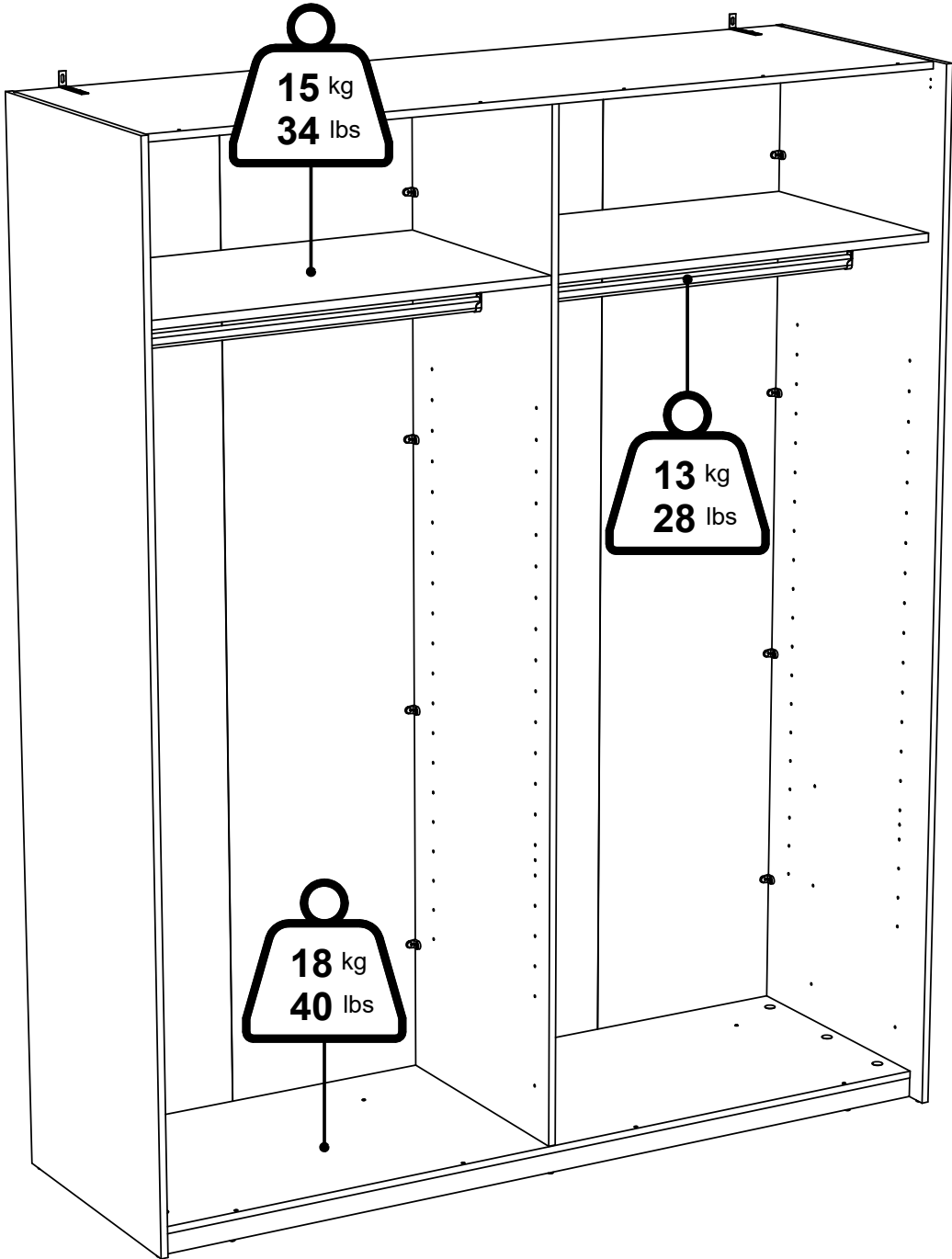
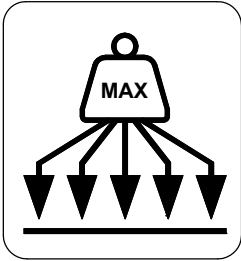

<https://quefairedemesdechets.fr>