

PENRITH

Art.-Nr. 12406650 / 12406660 / 12406670/ 12406680

09.04.2026

3028602

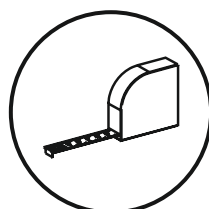
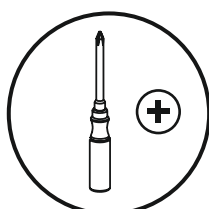
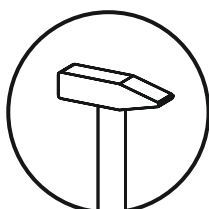

DE Bitte die Montageanleitung vor Beginn sorgfältig studieren. Um eine ordnungsgemäße und mangelfreie Erstellung zu gewährleisten, muss die Montage exakt in der gezeigten Reihenfolge ausgeführt werden. Wir empfehlen die Montage nur durch Fachkundiges Personal. Entsorgen Sie die Verpackung bzw. das Produkt nach Abnutzung umweltgerecht.

Pflegehinweis!

Bitte nur mit einem Staubtuch oder einem feuchten Lappen reinigen. Keine scheuernden Putzmittel verwenden!
Hochglanzfronten erst 48 Std nach Entfernung der Schutzfolie reinigen.
Hochglanzfronten nur mit weichem Tuch und 1%iger Wasser-Seife-Lösung reinigen - keine scheuernden Mittel, Säure, Lösungsmittel, Spiritus, Azeton etc. verwenden!
Hochglanzfronten vordauerhafter Feuchtigkeit schützen.

Wandmontage:

Der Untergrund der Wand ist vor der Montage auf die Eignung (Tragfähigkeit) zu prüfen. Das beiliegende Befestigungsmaterial ist nur für massives Mauerwerk geeignet!

Bitte ersetzen Sie gebrochene Schutzscheiben der Halogenstrahler umgehend.

GB Please carefully read through the assembly instructions before starting. To ensure proper, fault-free construction, assembly is to be carried out exactly as shown in the sequence. We recommend having the assembly done only by qualified personnel. Please dispose of the packaging and of an old product no longer in use without any danger to the environment.

Care instructions!

Please do only clean with a duster or or a damp cloth. Do not use any scouring agents!
After removing the protective foil, wait for 48 hours before cleaning high gloss fronts for the first time.
Clean high gloss fronts only with a soft cloth and a 1% soap and water solution - do not use abrasive cleaning agents, acids, solvents, methylated spirits, or acetone etc.!
Protect high gloss fronts from sustained exposure to moisture.

Wall fixing:

The foundation of the wall must be checked for suitability (stability) before assembly. The enclosed mounting material is only suitable for solid brickwork!

In event of breakage, be sure to replace protective screen of the halogen lamps immediately.

FR Lire scrupuleusement les instructions de montage avant de commencer le montage. Afin de garantir une construction conforme et irréprochable, le montage doit être effectué exactement dans l'ordre indiqué. Nous recommandons de ne faire effectuer le montage que par du personnel qualifié. Veuillez vous débarrasser de l'emballage ou du produit après son utilisation selon les conditions sur l'environnement.

Indications d'entretien !

Ne nettoyer qu'avec un chiffon à poussière ou un chiffon humide. Ne pas utiliser de produit à récurer !
Ne nettoyer les devants brillants que 48 heures après avoir enlevé le film protecteur.
Ne nettoyer les devants brillants qu'avec un chiffon doux imbibé d'une solution savonneuse à 1 % - ne pas utiliser de produits agressifs ni d'acides, de solvants, d'alcool, d'acétone, etc.
Protéger les devants brillants de toute humidité durable.

Montage mural:

Avant l'assemblage, il faut vérifier l'aptitude (pouvoir porteur) du fond du mur. Les matériaux de fixation ci-joints ne conviennent que pour des murs massifs !

En cas de rupture, veuillez remplacer immédiatement les vitres de protection des lampes halogènes.

ES Antes de empezar lea detenidamente las instrucciones de montaje. Para garantizar una construcción adecuada y sin defectos, el montaje deberá llevarse a cabo en el orden exacto que se indica. Le recomendamos que el montaje lo efectúe únicamente personal especializado. Desechar por favor el embalaje o producto ateniéndose a las normas ecológicas vigentes una vez que éste se haya desgastado.

Indicaciones de mantenimiento!

Limpiar sólo con un trapo para el polvo o con un trapo húmedo. No utilizar productos de limpieza abrasivos!
Los frentes de alto brillo no han de limpiarse hasta 48 horas después de retirarse la lámina de protección.
Los frentes de alto brillo sólo han de limpiarse con un paño suave y una solución de agua-jabón al 1% - no deben utilizarse medios abrasivos, ácido, disolventes, alcohol, acetona, etc.!
Los frentes de alto brillo han de protegerse contra humedad permanente.

Montaje en pared:

Antes del montaje, comprobar que la estructura de la pared sea adecuada (estática). ¡El material de fijación suministrado sólo es indicado para mampostería maciza!

Cambiar de inmediato los vidrios protectores de los focos halógenos cuando se rompan.

PL Przed rozpoczęciem montażu proszę uważnie zapoznać się ze stosowną instrukcją. Aby zapewnić prawidłowe przeprowadzenie montażu należy wykonywać wszystkie czynności dokładnie wg przedstawionej kolejności. Polecamy montaż wyłącznie przez fachowy personel. Produkt po zużyciu i jego opakowanie utylizować w ekologicznie właściwy sposób.

Pielęgnacja!

Czyścić tylko przy pomocy suchej lub wilgotnej ściereczki. Nie stosować środków do szorowania!
Frontowe powierzchnie mebli o wysokim połysku prosimy czyścić dopiero po 48 godzinach po usunięciu folii ochronnej.
Frontowe powierzchnie mebli o wysokim połysku prosimy czyścić miękką szmatką zwilżoną w 1% roztworze wody z mydłem - nie wolno stosować jakichkolwiek środków ściernych, kwasów, rozpuszczalników, spirytusu, acetonu itp.!Frontowe powierzchnie mebli o wysokim połysku prosimy chronić przed ciągłym działaniem wilgoci.

Sposób montażu na ścianie:

Przed montażem należy zbadać podłoże ściany pod względem podatności (nośności). Załączony materiał mocujący nadaje się tylko do masywnego muru!

Proszę niezwłocznie wymienić uszkodzone szyby ochronne reflektora halogenowego.

CZ Prostudujte, prosím, před začátkem práce pečlivě Montážní návod. Aby bylo zaručeno řádné a bezchybné sestavení, musí se montáž provést přesně v uvedeném pořadí. Doporučujeme, aby montáž prováděl již dýjen odborník. Po použití likvidujte obal nebo výrobek ekologicky.

Pokyny pro ošetřování!

Čistěte, prosím, pouze prachovkou nebo vlhkým hadrem. Nepoužívejte abrazivní čisticí prostředky!
Přední stěny s vysokým leskem čistit teprve 48 hodin po odstranění ochranné fólie.
Přední stěny s vysokým leskem čistit jen měkkou tkaninou a 1%-ním mýdlovým roztokem - nepoužívat žádné abrazivní čisticí prostředky, kyseliny, ředidla, líh, aceton atd.!Přední stěny s vysokým leskem chránit před dlouhodobou vlhkostí.

Montáž nastěnu:

Podklad stěny se před montáží musí zkontrolovat z hlediska vhodnosti (nosnosti). Přiložený upevňovací materiál je vhodný jen pro masivní zdivo !

ihned, prosím, vyměňte rozbité ochranné tabulky halogenových svítidel.

SK Pred začoátím prác si prosíme starostlivo prečítajte návod na montáž. Aby bolo možné zaručiť správne a bezchybné zostavenie, je nutné pri montáži dodržať presne vyznačený postup. Odporúčame nechať urobiť montáž odborníkovi. Obal resp. produkt po opotrebení zlikvidujte ekologicky.

Pokynk údržbe!

Prosíme utierať len prachovkou alebo vlhkou handričkou. Nepoužívať žiadne čistiace prostriedky na drhnutie!
Čelá vo vysokom lesku čistíte až 48 hod. po odstránení fólie
Čelá vo vysokom lesku čistíte len mäkkou handrou a 1%-ným mydlovým roztokom, nepoživate žiadne agresívne prostriedky, kyseliny, riedidlá, lieh, acetón a pod.!Čelá vo vysokom lesku chráňte pred pôsobením trvalej vlhkosti.

Montáž nastenu:

Pred montážou je potrebné skontrolovať vhodnosť (únosnosť) podkladu steny. Priložený upevňovací materiál je vhodný iba pre masívne murivo !

Prosím, ihneď vymeňte zlomené ochranné dosky halogénového žiariča.

HU Kezds előtt gondosan tanulmányozza a szerelési utasítást! A szabályszerű és hibátlan elkészítés garantálása érdekében a szerelést pontosan a mutatott sorrendben kell elvégezni. Javasoljuk, hogy csak szakképzett személyzet végezze el a szerelést. Kérjük, hogy a csomagolást, illetve a terméket elhasználódás után környezetkímélő módon takarítsa el.

Ápolási útmutatás!

Kérjük, hogy csak portörölő kendővel vagy nedves ronggyal tisztítsa! Ne használjon dörzsölőhatású tisztítószeret!
Acsillogó felületeket csak a 48 órával a védőfólia eltávolítása után tisztíthatja. A csillogó felületeket csak lágy törölőkendővel és 1%-os szappanos víz oldattal tisztítsa. Ne használjon súrolószereket, savakat, oldószereket, alkoholt, acetont, stb.!Védje a csillogó felületeket a folyamatos nedvességtől.

Falaszereles:

Szerelés előtt meg kell vizsgálni a fal alaptalajának az alkalmasságát (teherbíró képességét). Amellékelt rögzítő anyag csak masszív falazatra alkalmas!

Halogén sugárzók tört védőüvegét kérjük cserélje ki azonnal.

IT Per favore prima dell'inizio studiare accuratamente le istruzioni per il montaggio. Per garantire una realizzazione senza errori, il montaggio deve essere fatto rispettando esattamente la sequenza indicata..
Consigliamo di far eseguire il montaggio esclusivamente da parte di personale esperto.
Non disperdere nell'ambiente e provvedere ad uno smaltimento ecologico dopo l'uso.

Istruzione di cura!

Per favore pulire solo con un panno per rimuovere polvere o con uno straccio umido. Non usare detergenti abrasivi!
Pulire le parti anteriori ad elevata lucentezza solo a 48 ore dalla rimozione della pellicola protettiva.
Pulire le parti anteriori ad elevata lucentezza solo con un panno morbido e una soluzione di sapone e acqua all'1%. Non utilizzare prodotti abrasivi, acidi, soluzioni, spirito, acetone, ecc.!
Proteggere le parti anteriori ad elevata lucentezza dall'umidità costante.

Montaggio su parete:

Prima del montaggio è necessario verificare l'idoneità del fondo della parete (portata).
Il materiale di fissaggio allegato è adatto solo per opere in muratura piena!

Sostituire immediatamente il vetro protettivo rotto dei faretti alogeni.

RU Пожалуйста перед началом монтажа, изучите внимательно инструкцию. Для того чтобы гарантировать соответствующее и безупречное производство, монтаж должен быть осуществленным в указанном порядке.
Мы советуем монтаж только от квалифицированного персонала.
Упаковка и соответственно продукт после износа, должны быть устранены соответствующе окружающей среде.

Инструкция по уходу!

Пожалуйста протереть только сухой или слегка влажной тряпкой для пыли. Не в коем случае не употребляйте хемических средств для чистки!
Глянцевые фасады чистить не раньше, чем через 48 часов после удаления защитной пленки.
Глянцевые фасады чистить только мягкой тканью с применением однопроцентного водно-мыльного раствора – ни в коем случае не применять царапающих средств, кислоты, растворители, спирт, ацетон и т.п.!

Монтаж на стене:

Проверьте пожалуйста до начало монтажа, стену на достаточную несущую способность. Материал для монтажа предназначен только для особенно стабильных стен.!

Пожалуйста замените немедленно разбитое защитное стекло галогенного освещения.

SI Pred začetkom, prosimo, navodilo za montažo skrbno študirajte. Za zagotovitev redne in nepomanjkljive izdelave se mora montaža izvesti natančno v prikazanem vrstnem redu.
Priporočamo, da montažo opravite strokovno osebje.
Poskrbite za okolju prijazno odstranitev embalaže oz. produkta po uporabi.

Navodilo za nego!

Čistite, prosimo, le s krpo za prah ali z vlažno krpo. Ne uporabljajte nobenih grobih čistil!
Površine z visokim leskom očistite komaj 48 ur po odstranitvi zaščitne folije.
Površine z visokim leskom čistite samo z mehko krpo in 1-odstotno milnico - ne uporabljajte sredstev za drgnjenje, kisline, topil, špirta, acetona itd.!

Montaža na zid:

Pred montažo se mora preveriti primernost (nosilnost) podtalja zidu.
Priloženi material za pritrdjevanje je primeren le za masivno zidovje!

Prosimo vas, da nemudoma nadomestite polomljene varovalne ploščice halogenskega sevalnika.

NI Lees de betreffende instructies zorgvuldig door voordat u met de installatie begint.
Om ervoor te zorgen dat de installatie correct wordt uitgevoerd, moeten alle stappen in de juiste volgorde worden uitgevoerd.
Wij raden aan de installatie uitsluitend door gekwalificeerd personeel te laten uitvoeren.
Het product en de verpakking moeten na gebruik op milieuvriendelijke wijze worden verwijderd.
Verzorging!
Alleen schoonmaken met een droge of vochtige doek. Gebruik geen schuurmiddelen!
Reinig de voorkant van hoogglansmeubelen niet eerder dan 48 uur na het verwijderen van de beschermfolie.
Hoogglanzende meubeloppervlakken moeten worden gereinigd met een zachte doek die is bevochtigd met een oplossing van zeepwater van 1% - gebruik geen schuurmiddelen, zuren, oplosmiddelen, spiritus, aceton, enz.!

BG Преди монтажа внимателно разучете инструкцията. Монтажът задължително трябва да се извърши в посочената последователност, за да отговаря на изискванията и да бъде безупречен.
Ние препоръчваме монтажът да се извършва от квалифициран персонал.
Изхвърляйте опаковката респ. вече негодния продукт според изискванията за опазване на околната среда.

Указание за поддръжка!

Почиствайте само с кърпа за прах или влажен парцал. Да не се използват абразивни почистващи препарати!
Почиствайте огледално лъскавите предни повърхности едва 48 часа след отстраняване на предпазното фолио
Почиствайте огледално лъскавите предни повърхности с мека кърпа и 1 % -ов разтвор на сапун във вода – не използвайте абразивни препарати, киселина, разтворител, спирт, ацетон и т.н.!

Монтаж върху стена:

Преди монтажа проверете дали е подходяща (устойчивост) основата на стената. Приложеният материал за закрепване е подходящ само за масивно строителство!

Моля да подменяте незабавно счупените предпазни шайби на халогенния светлинен източник.

TR Lütfen kurulum talimatları başlamadan önce dikkatle iyice inceleyiniz. Doğru ve hatasız üretim sağlamak için, montajı gösterilen sırada tam olarak yapılmalıdır. Biz montajı sadece eğitimli personel tarafından öneririz. Ambalaj ve ürünü kullanımdan sonra çevreye zarar vermeden yok edin.

Bakım talimatları!

Lütfen sadece bir toz bezi ya da nemli bir bezle temizleyiniz. Aşındırıcı temizlik maddeleri kullanmayın!
Parlak kapakları koruyucu filmi çıkardıktan sonra 48 saat sonra temizleyin.
Parlak Kapakları sadece yumuşak bir bez ile ve % 1'lik su sabun temizleyici ile temizleyin-aşındırıcı maddeler, asitler, çözücüler, alkol, aseton vb kullanmayın!
Parlak kapakları, sürekli neme karşı koru.

Duvarın montaj:

Duvarın uygunluğunu (taşınma kapasitesi) monte edilmeden önce test edilmelidir.
Dahil olan montaj donanımı sadece sağlam duvar için uygundur!

Lütfen holojin lambanın koruma camını kırıldığında hemen değiştirin.

RO Înainte de a începe, citiți cu atenție instrucțiunile de montaj. Pentru a se asigura un montaj corect și fără defecte, acesta trebuie realizat exact în ordinea indicată.
Recomandăm ca montarea să fie făcută doar de personal calificat.
Eliminați ambalajul, respectiv produsul după de s-a uzat, fără a afecta mediul înconjurător.

Indicație privind întreținerea!

Rugăm a se curăța doar cu o cârpă de șters praful sau cu o lavetă umedă. Nu folosiți materiale abrazive!
Curățați fațetele lucioase numai la 48 ore după îndepărtarea foliei de protecție .
Curățați fațetele lucioase numai cu lavetă moale și cu o soluție 1 % apă-săpun - nu utilizați agenți abrazivi, acizi, solvenți, spirit, acetonă etc.!

Montare pe perete:

Înainte de montare se va verifica dacă substratul peretelui este adecvat (dacă poate susține încărcătura). Materialul de fixare anexat este adecvat doar pentru zidărie masivă!
Rugăm să înlocuiți imediat geamurile de protecție sparte ale lămpilor cu halogen.

8,0 x 35,0mm

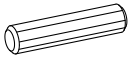

3003605

28 x A

7,0 x 50,0mm



3000534

10 x B

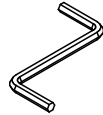

3000331

1 x C

15,0 x 12,0mm



3001728

10 x D



3002942

18 x E

3,5 x 16,0mm



3000574

24 x F

20mm



3025230-valnøddefarve, walnussfarbe,
couleur noyer, walnut / walnut color
3024202- egetræfarve, eichenfarbe / eiche,
couleur chêne, oak / oak color
3020881- greige, greige, greige,
greige, greige

6 x G

3,5 x 13,0mm



3000573

4 x H

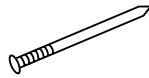

3001262

76 x I



3000545

12 x J

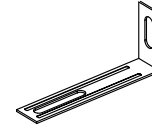

3002892

2 x K

20mm



3011364
biaty, hvid, weiß, blanc, white

8 x L

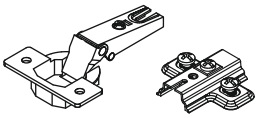

3017138

7 x M

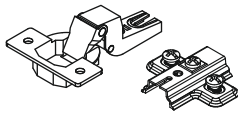

3005812

3 x N

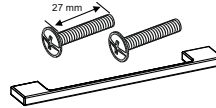

3021253

5 x O

6,0 x 30,0mm



3005048

8 x P

5,0 x 9,0mm



3024700

12 x Q

4,0 x 22,0mm

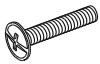

3000562

10 x R

3,0 x 20,0mm



3003843

22 x S



3011837

10 x T

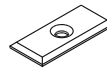

3002435

10 x U

15,0 x 10,0mm



3002649

8 x V

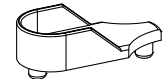

3001827

2 x W

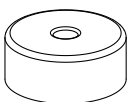

3011212

5 x AA



3000577

5 x AB

400mm

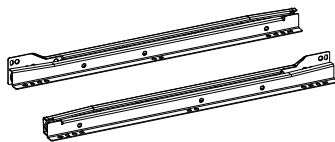

3013500

2 x X

400mm



2 x Y

885mm

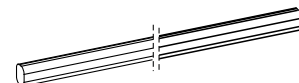

1 x Z

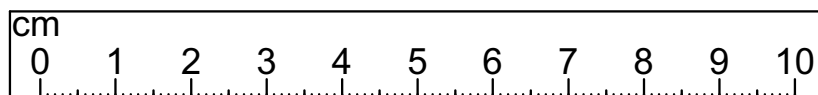

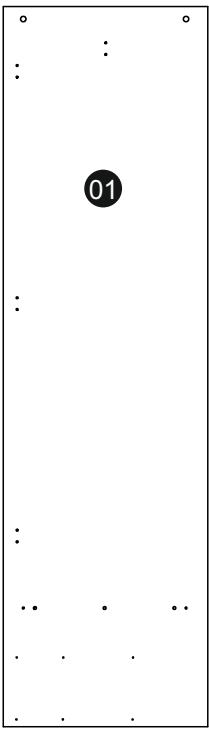

1984x563x16



1984x563x16

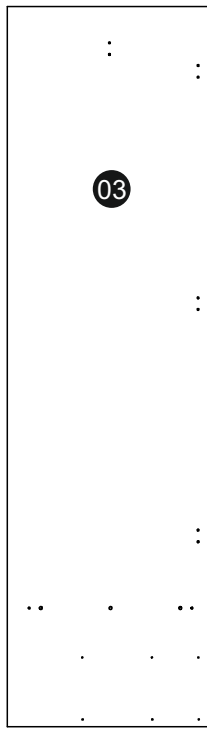

1984x563x16

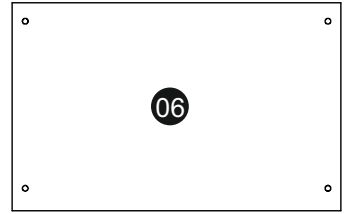

893x562x16

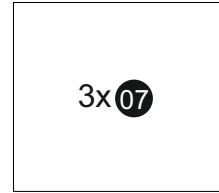

507x559x16

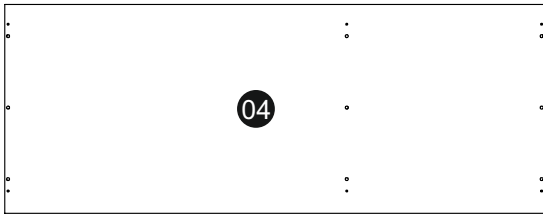

1450x564x16

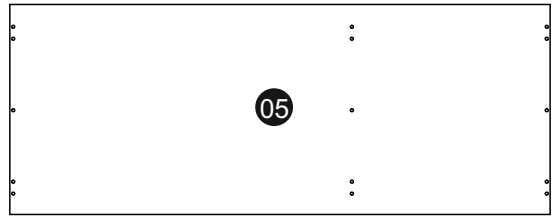

1450x564x16

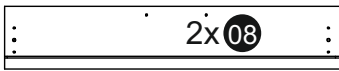

913x168x16

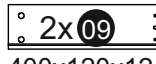

400x120x12

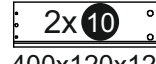

400x120x12



853x406x3



843x105x12

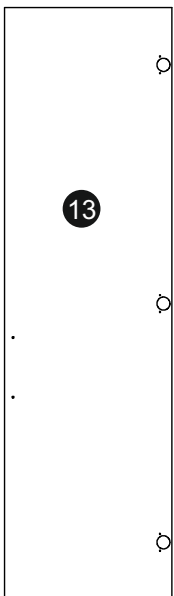

1669x455x16

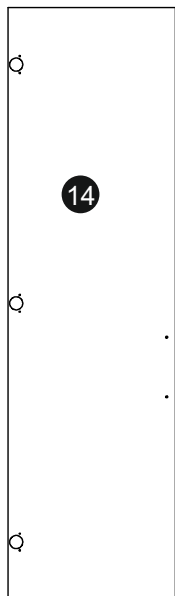

1669x455x16

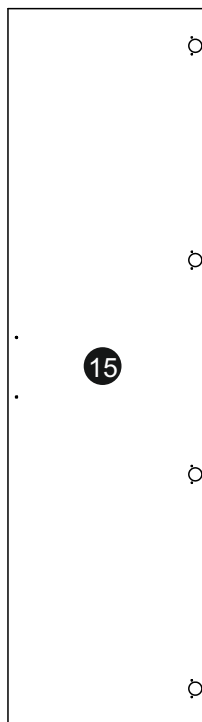

2011x526x16

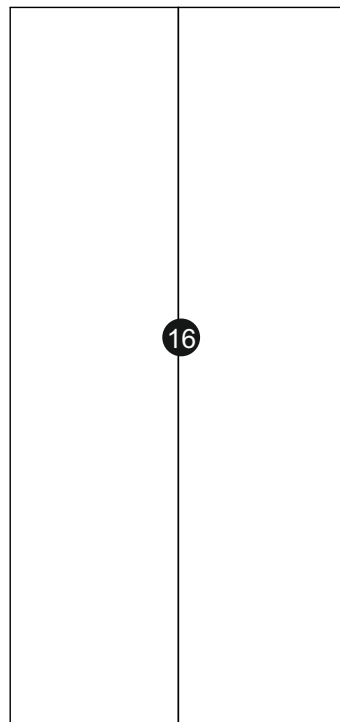

2014x916x3

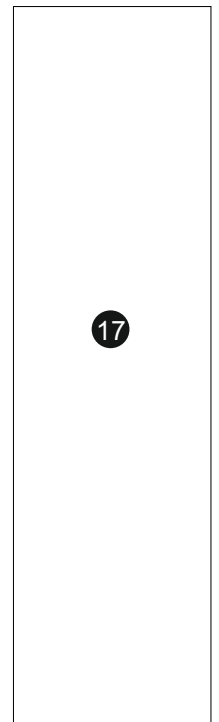

2014x530x3

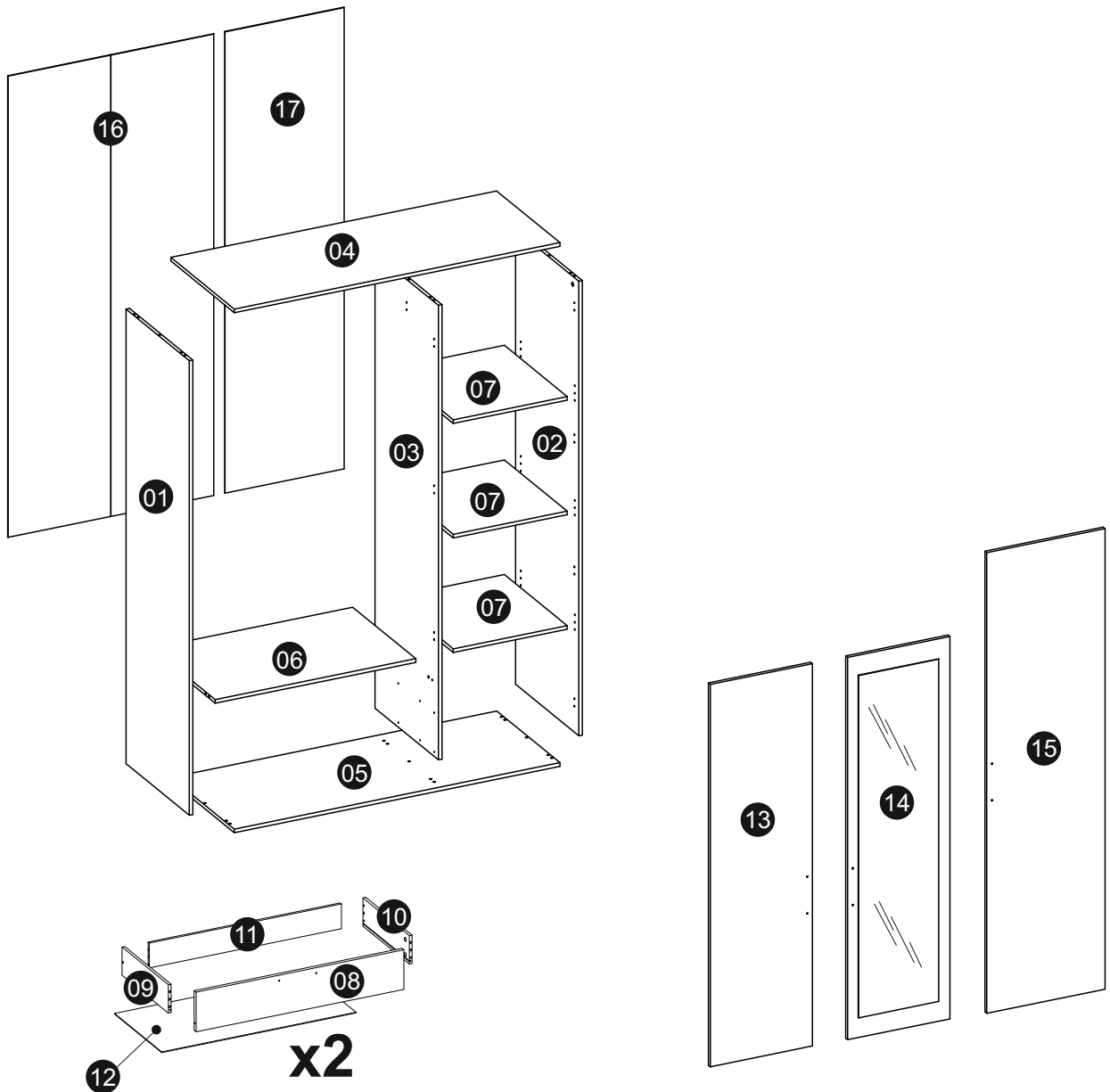
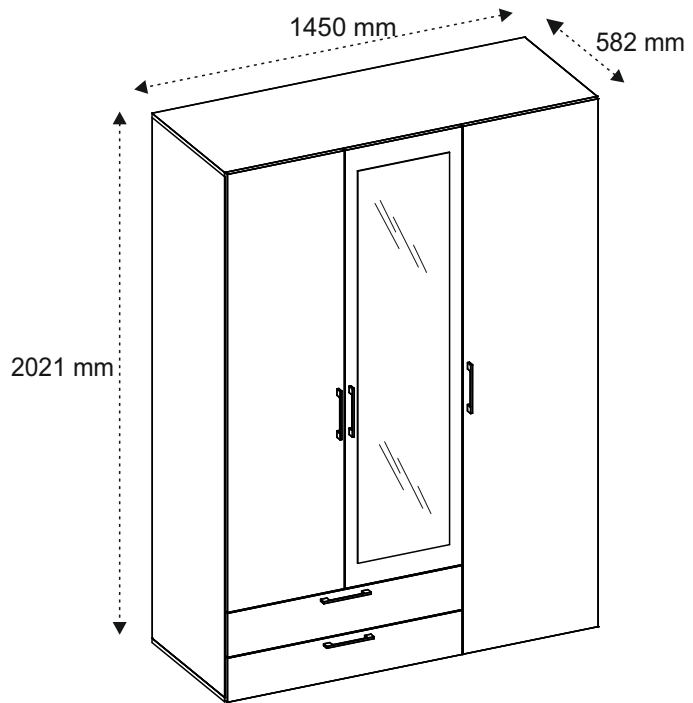

1

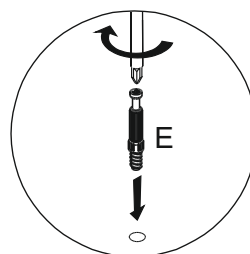
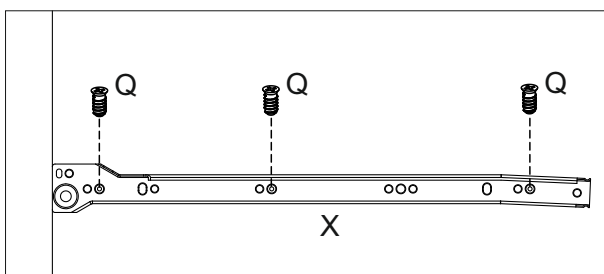
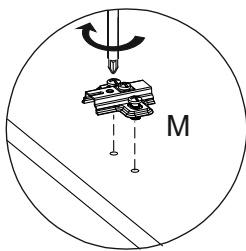
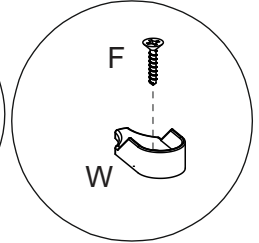
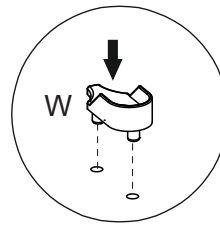
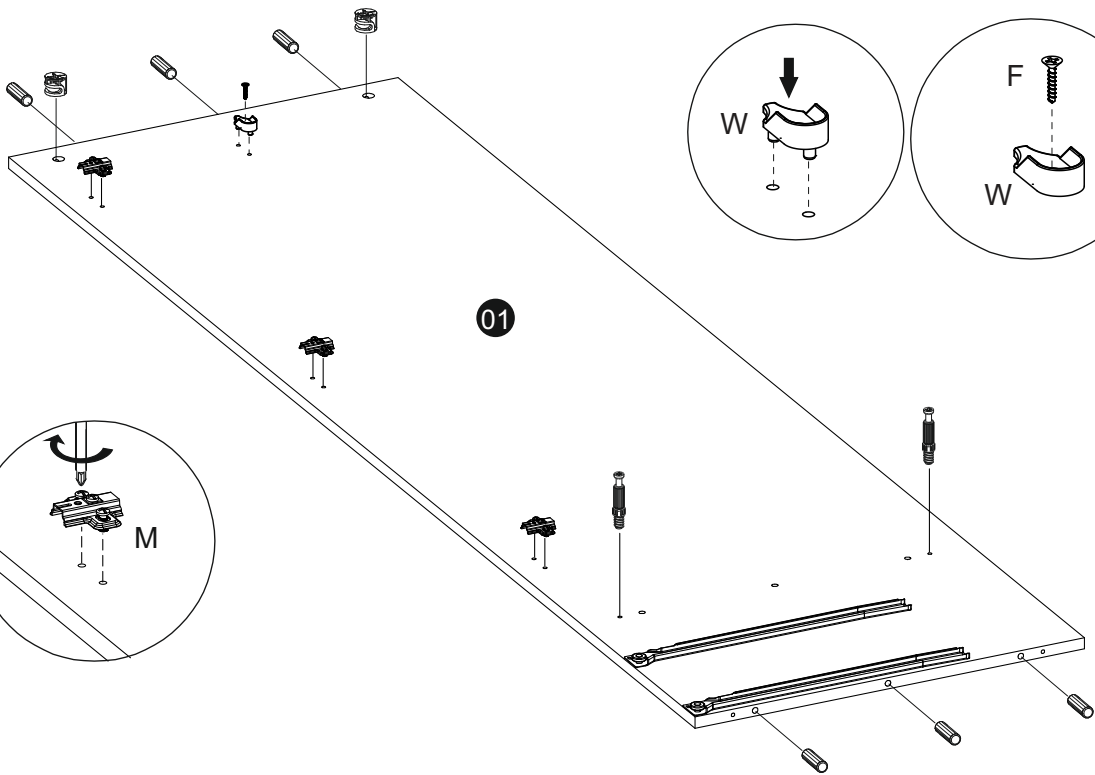
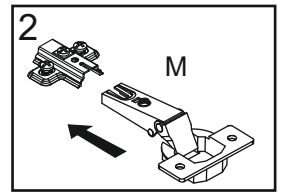
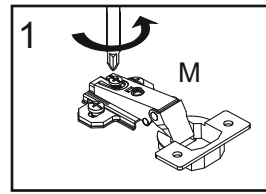
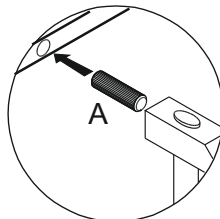
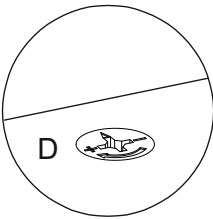
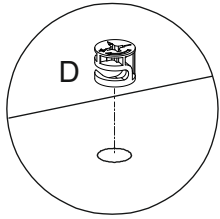
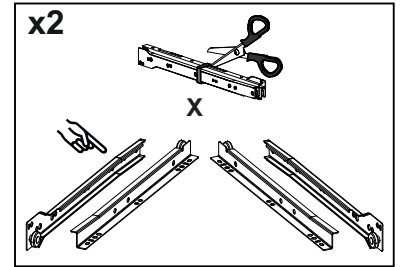
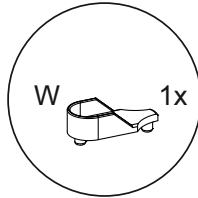
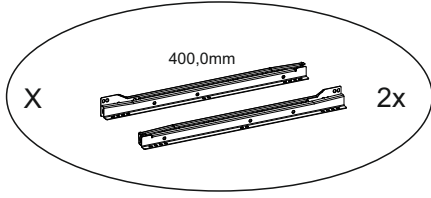
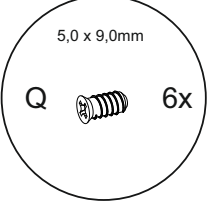
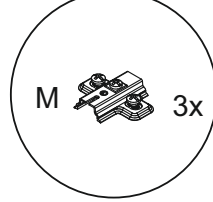
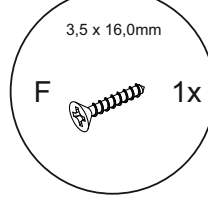
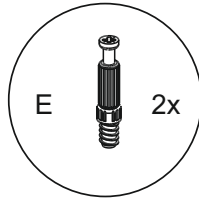
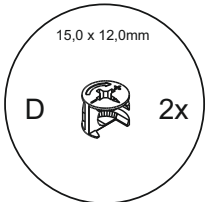
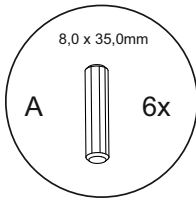

2

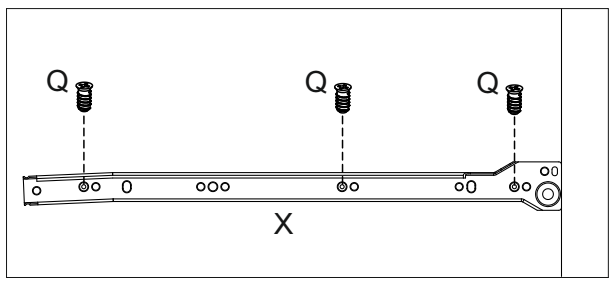
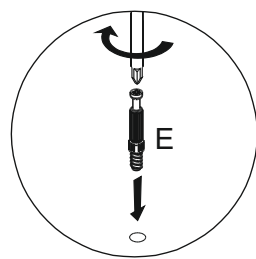
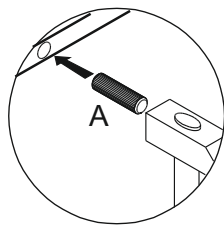
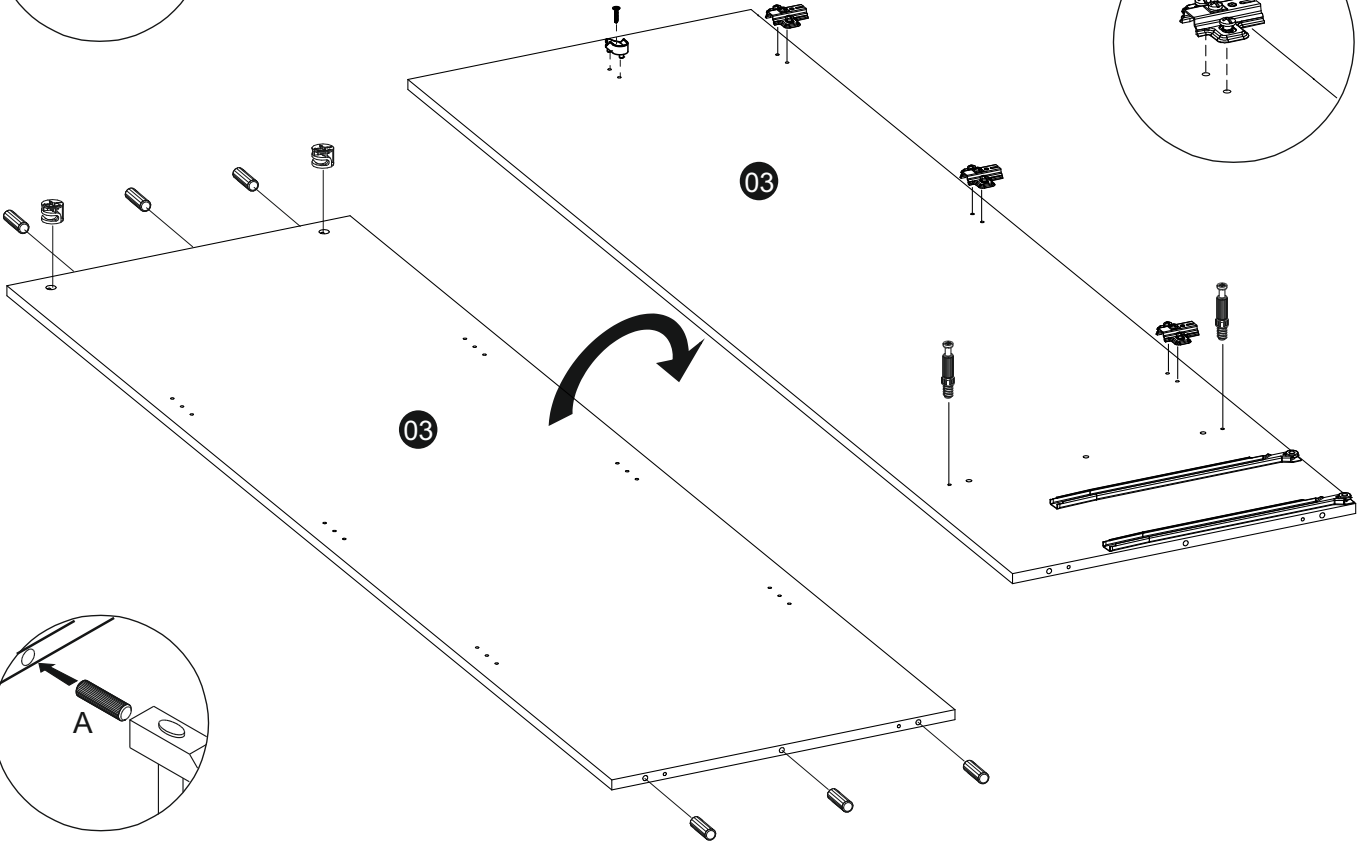
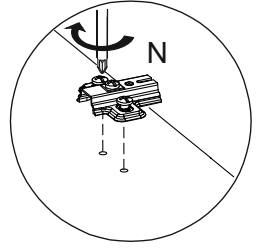
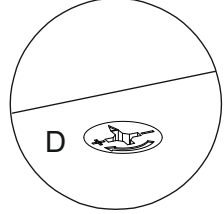
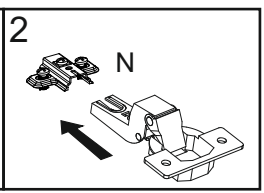
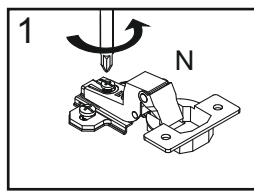
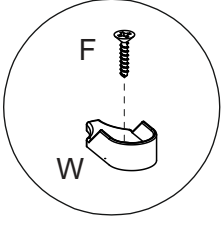
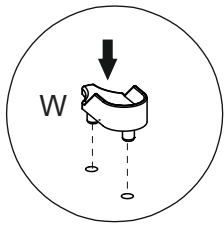
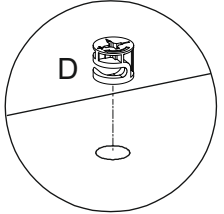
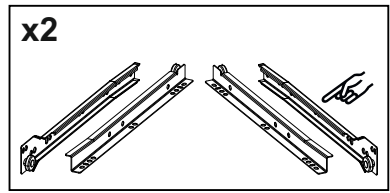
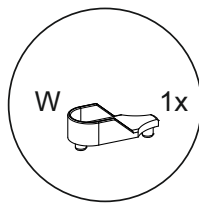
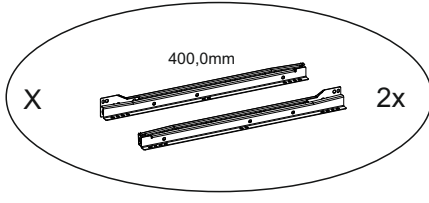
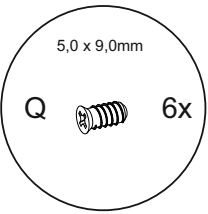
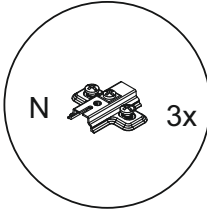
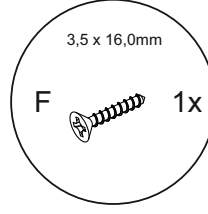
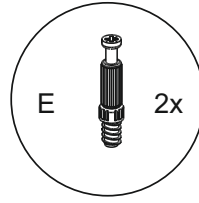
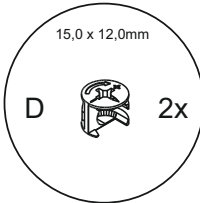
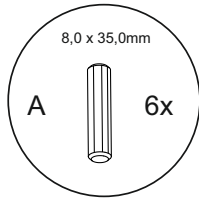

3

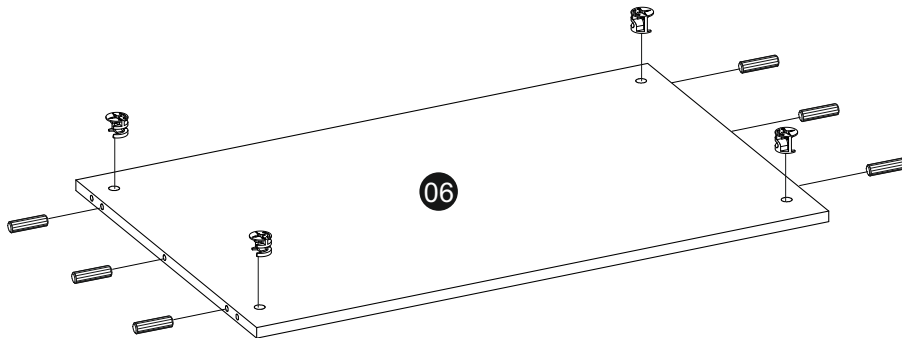
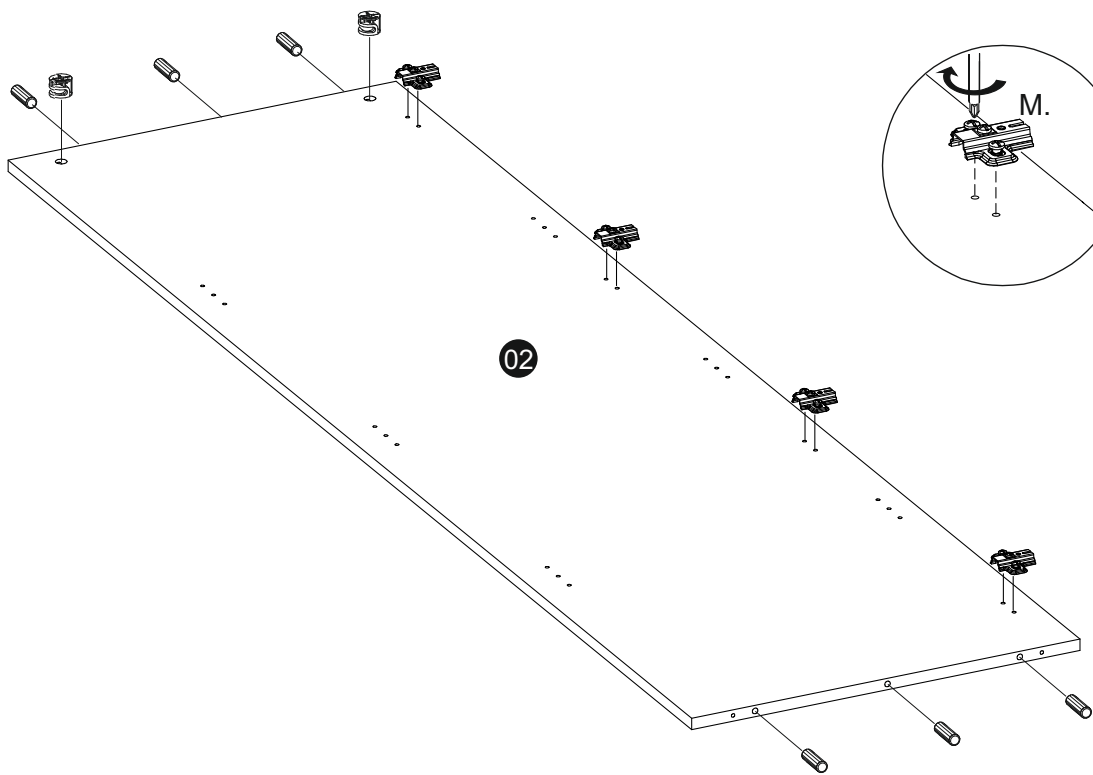
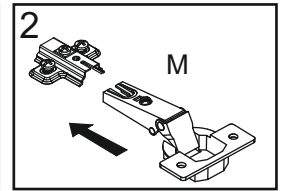
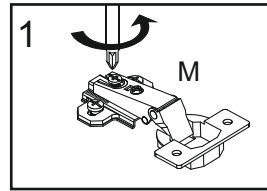
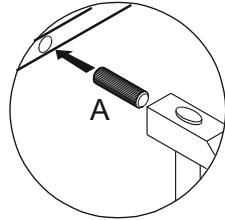
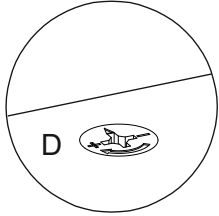
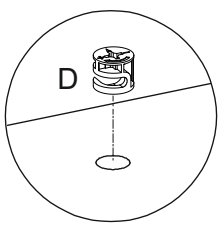
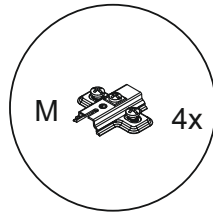
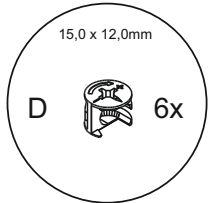
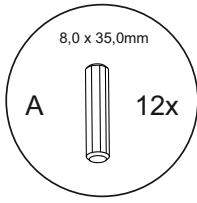

4

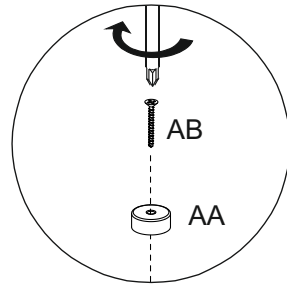
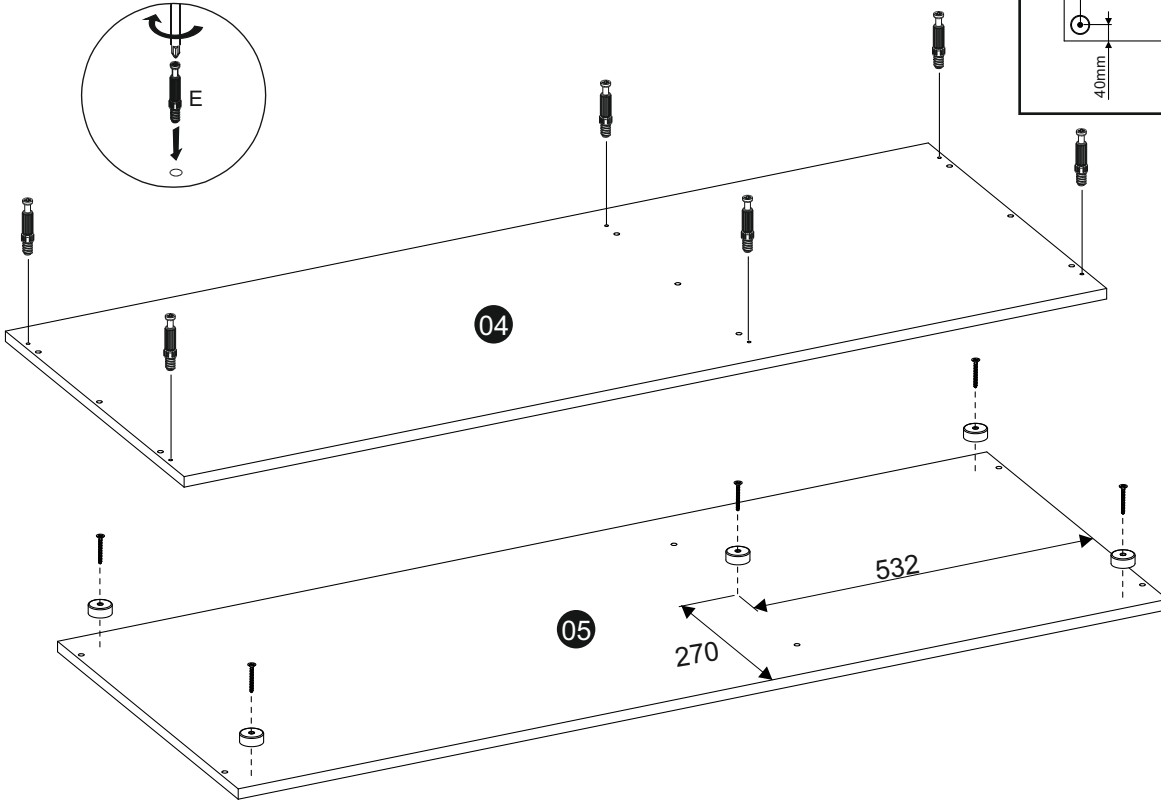
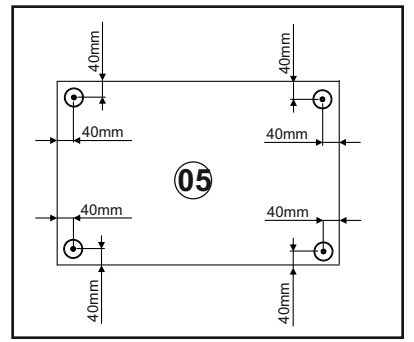
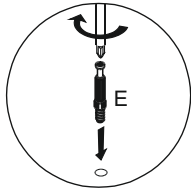
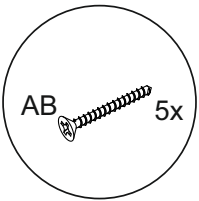
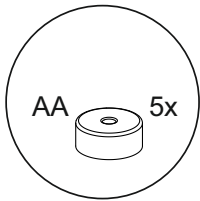
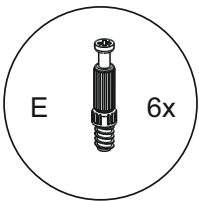

5

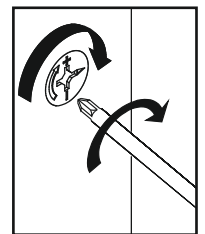
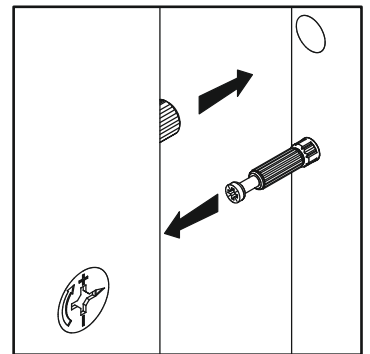
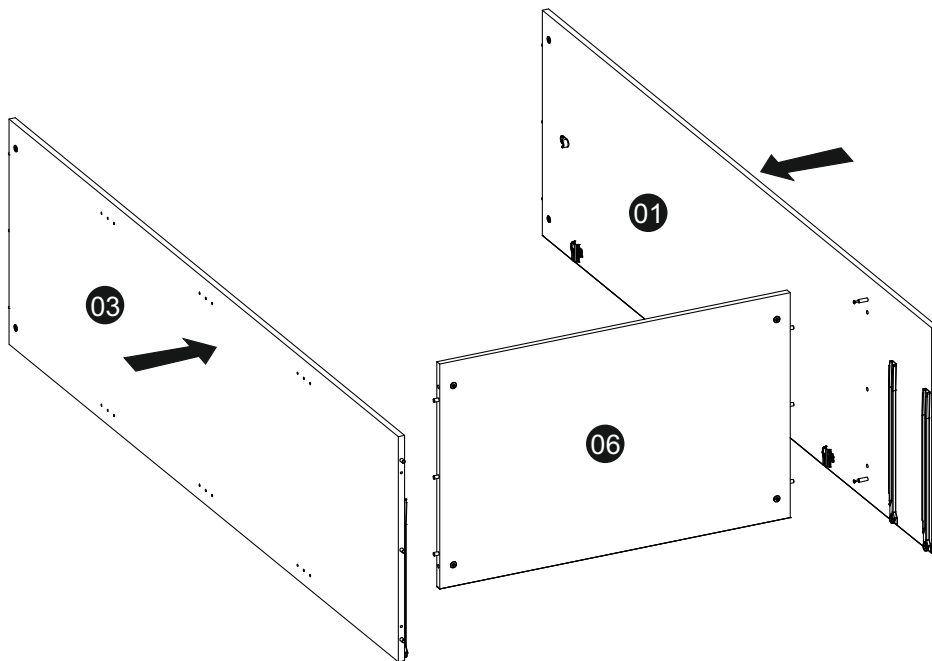

6

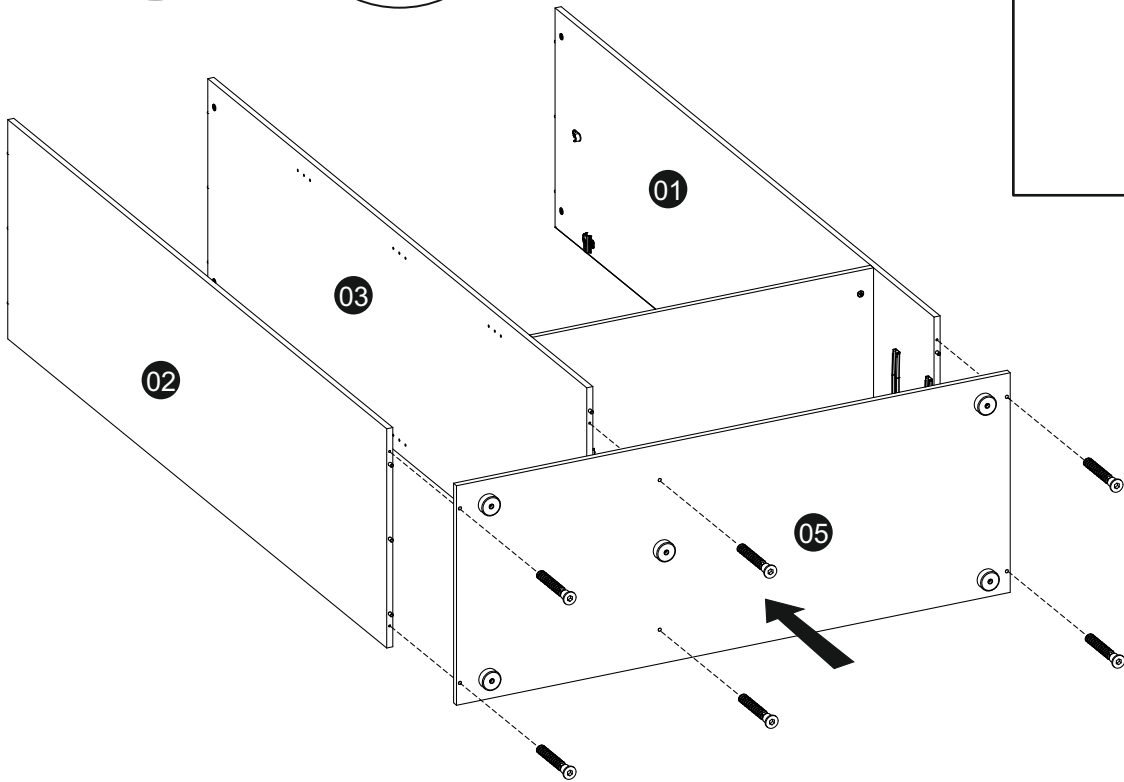
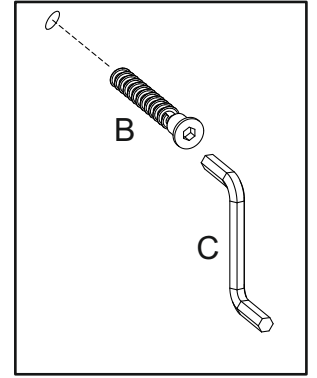
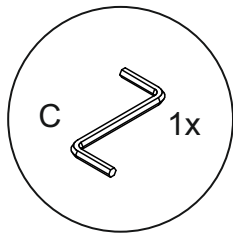
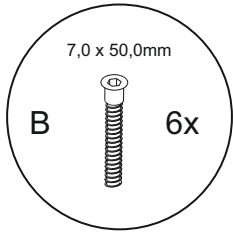

7

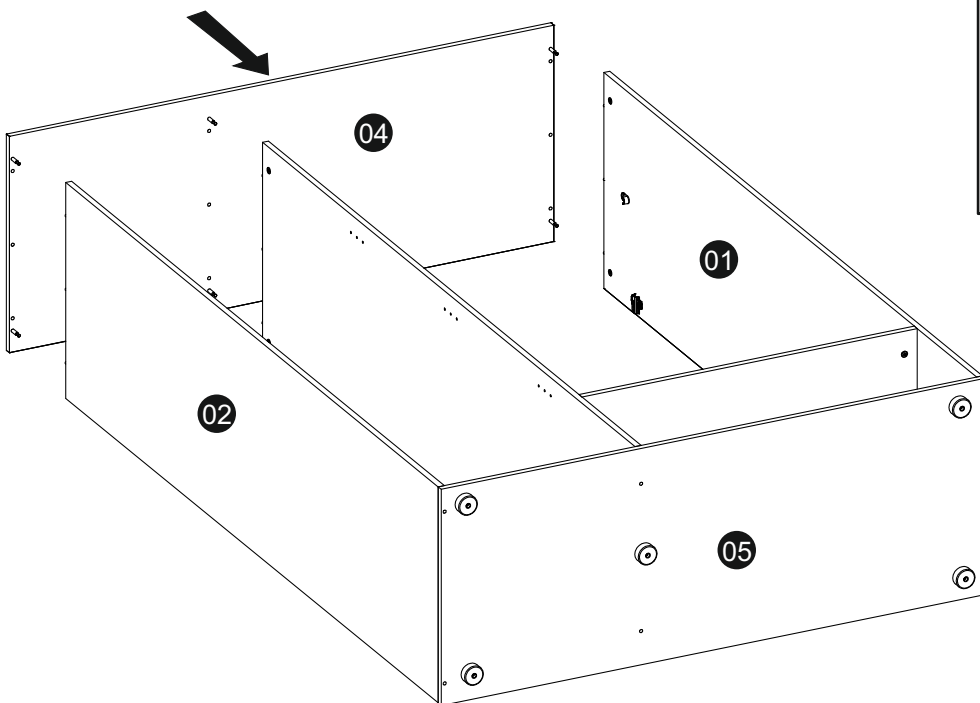
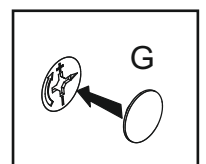
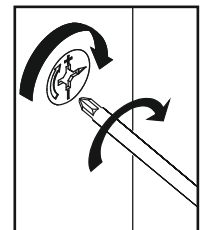
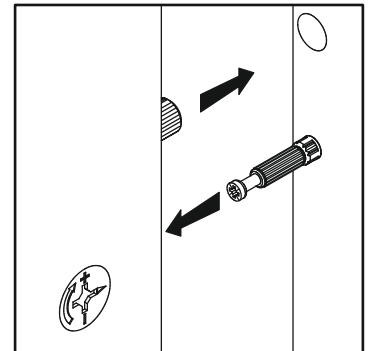
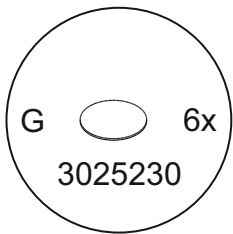

8

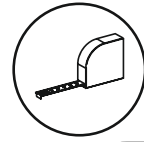
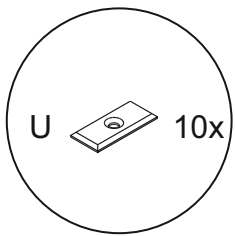
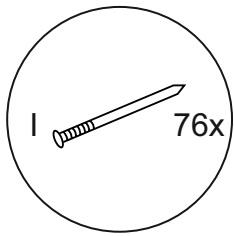

A=B

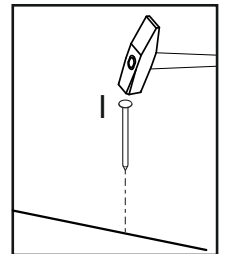
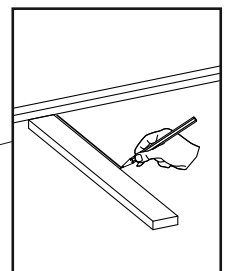
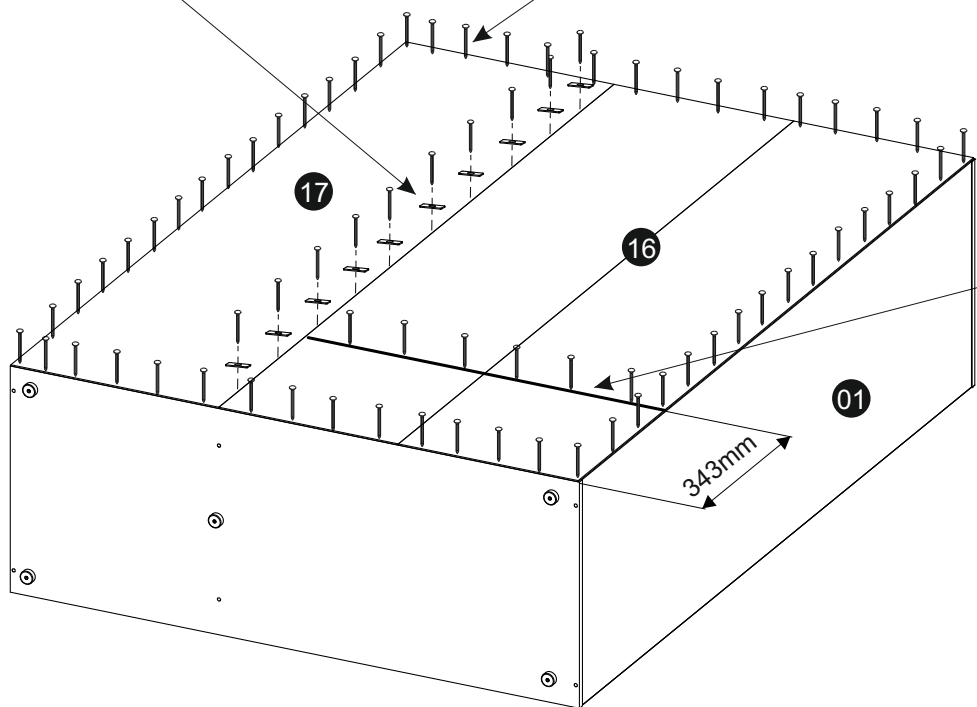
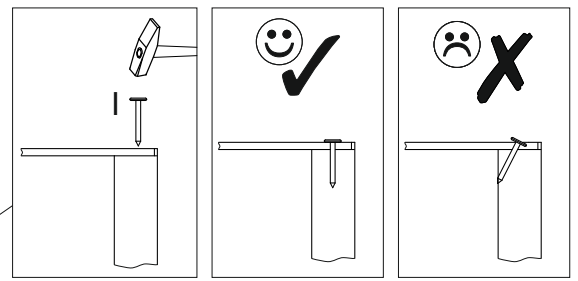
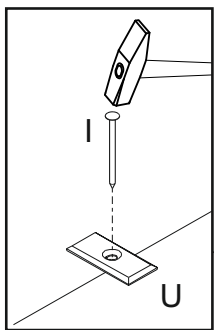
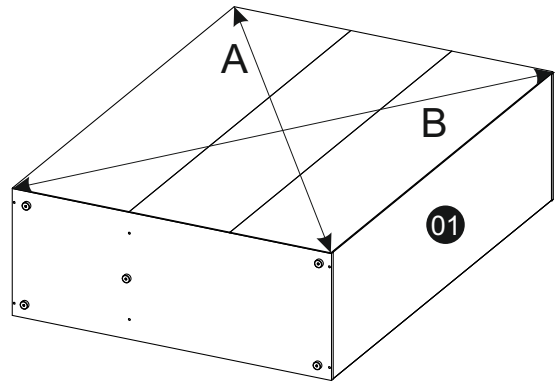
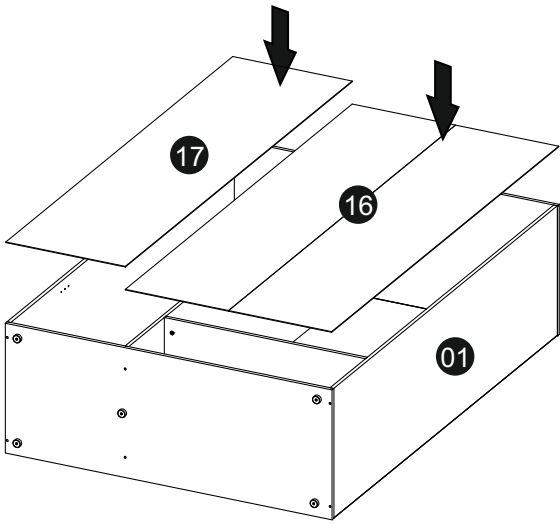
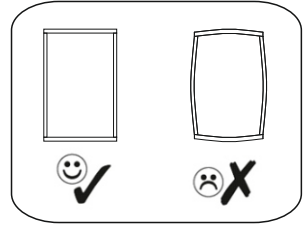

9

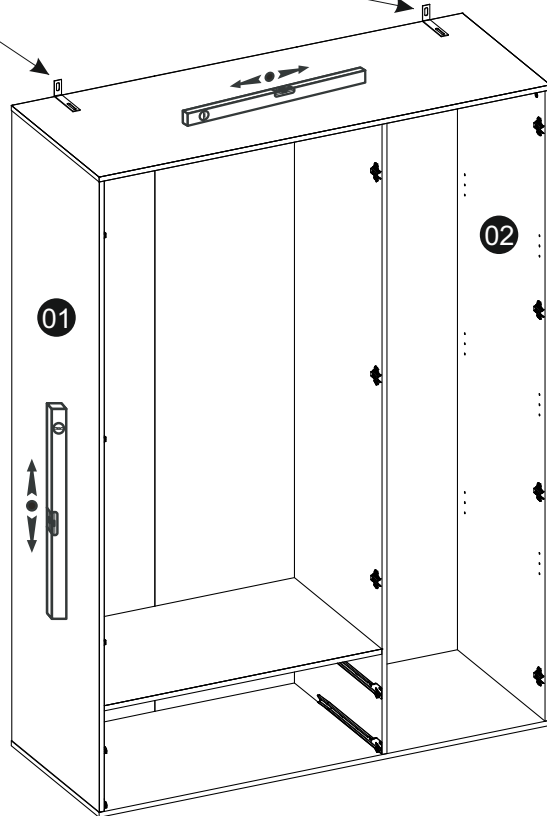
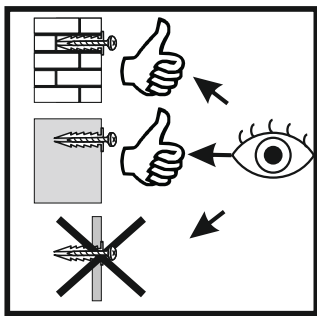
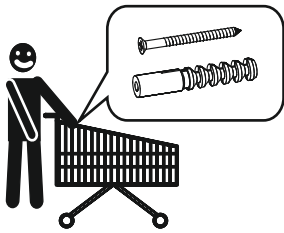
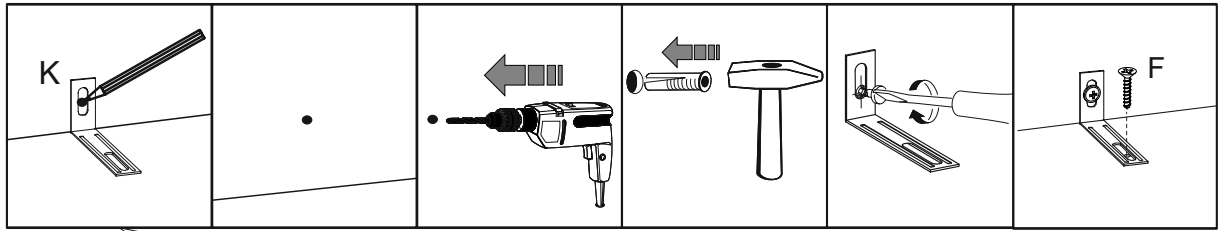
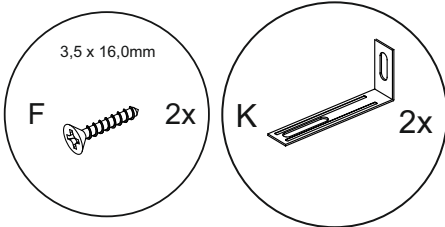

10

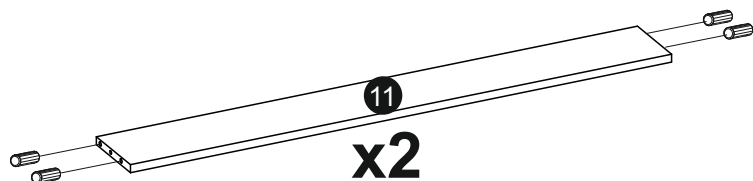
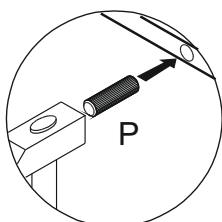
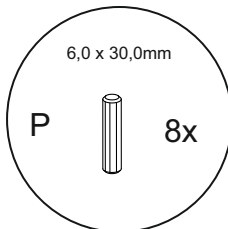

11

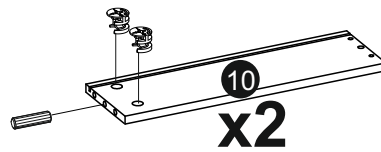
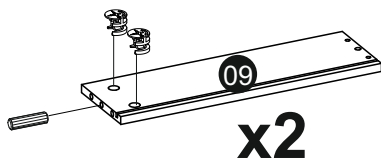
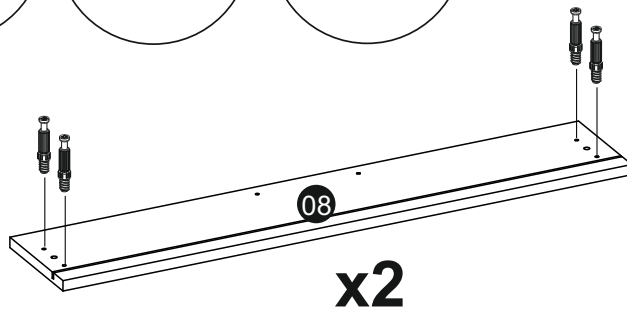
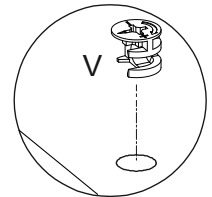
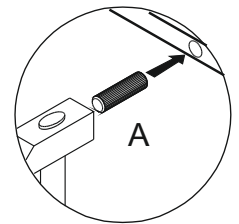
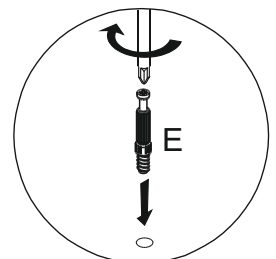
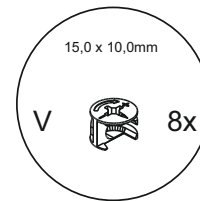
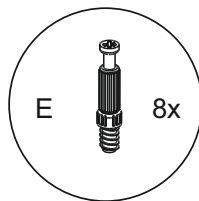
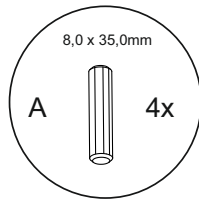

12

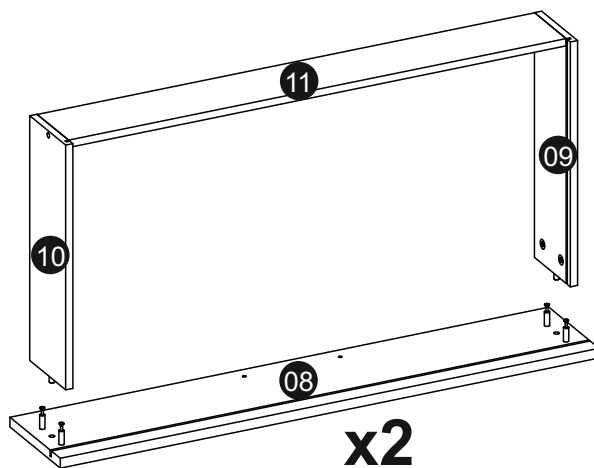
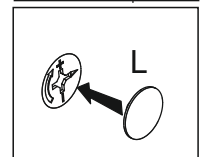
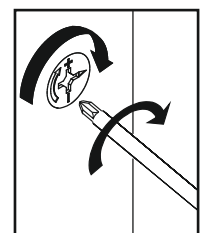
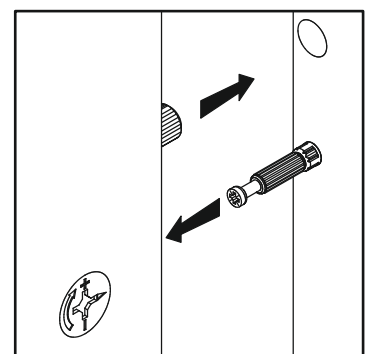
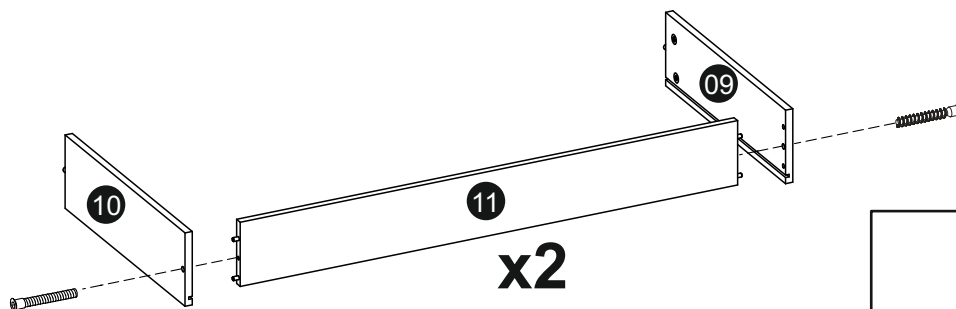
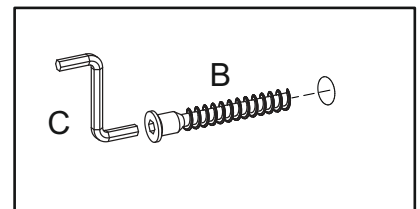
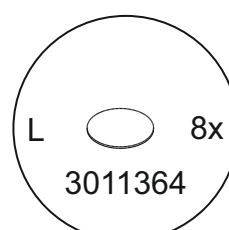
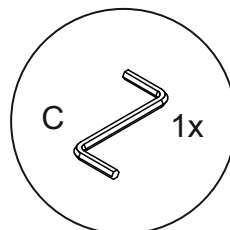
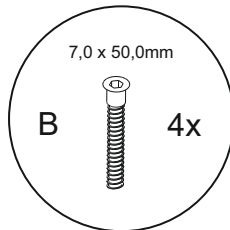

13

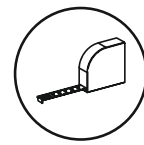
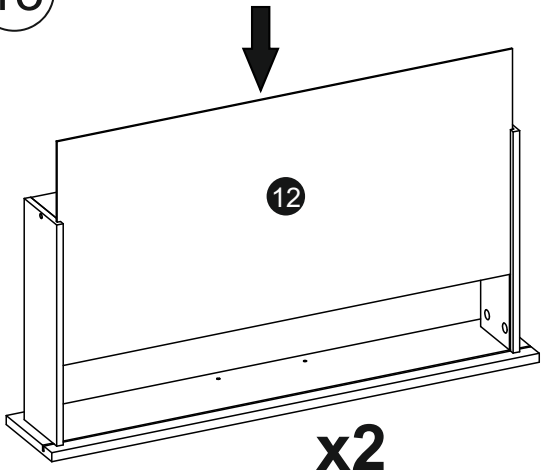

A=B

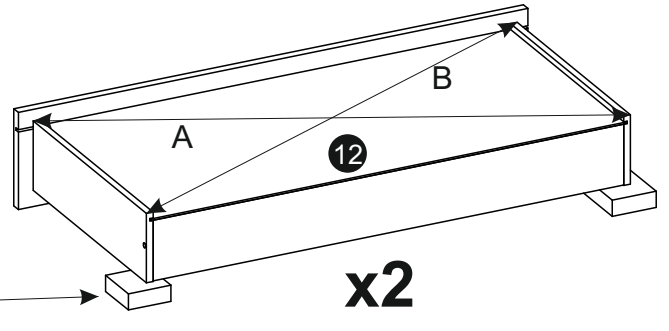

14

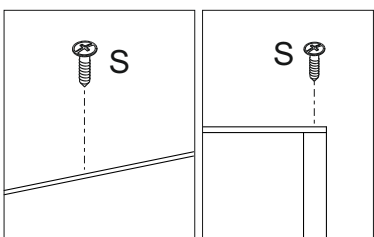
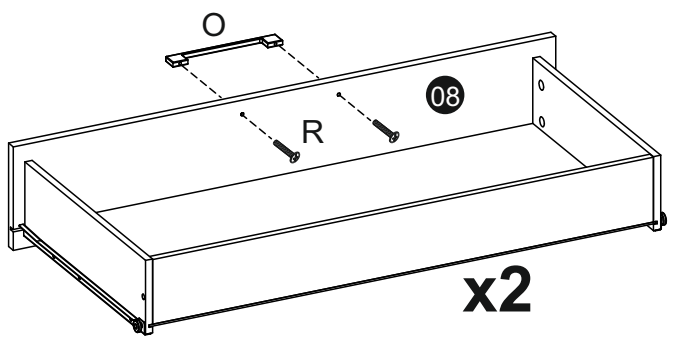
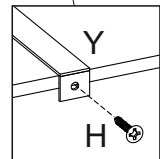
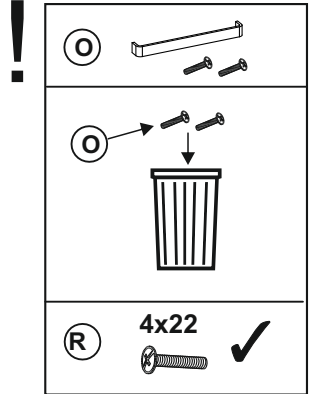
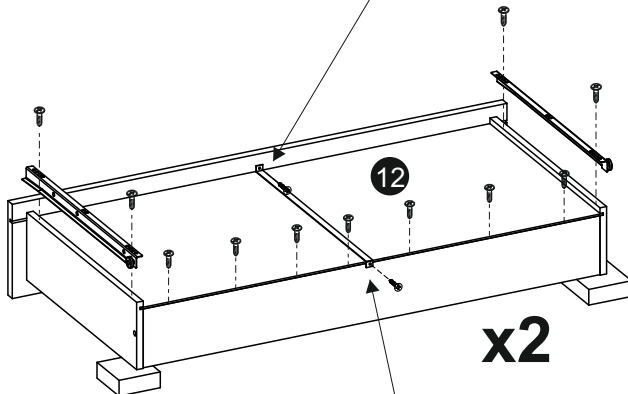
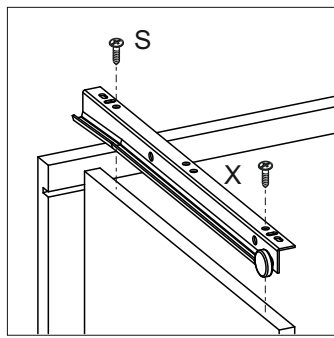
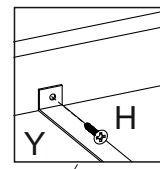
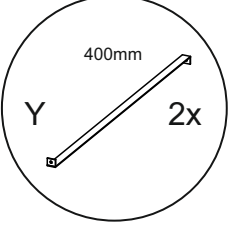
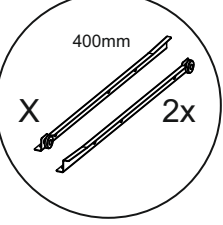
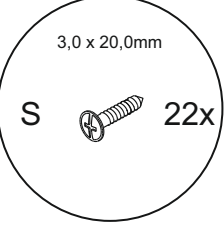
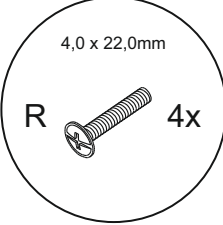
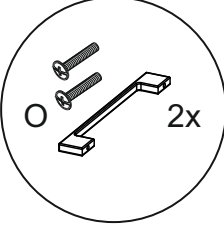
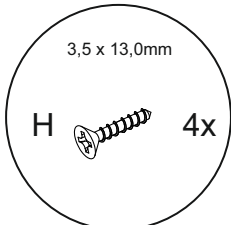

15

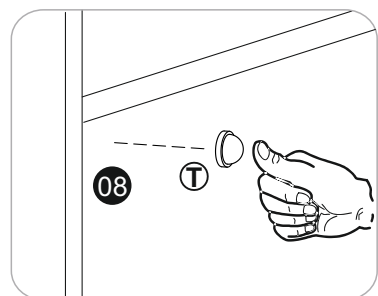
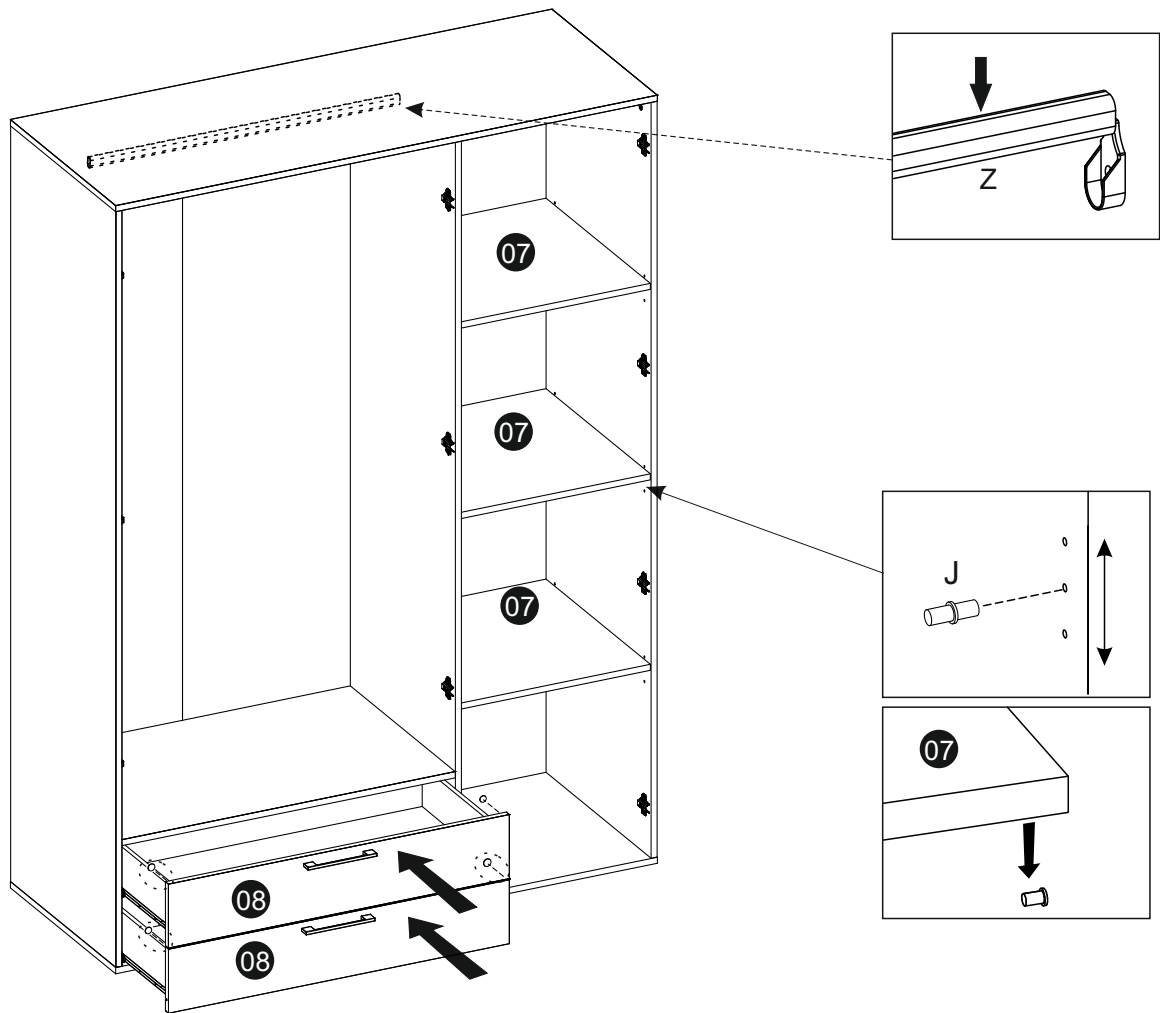
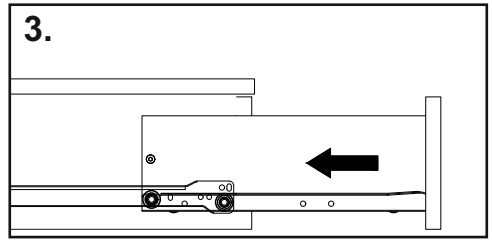
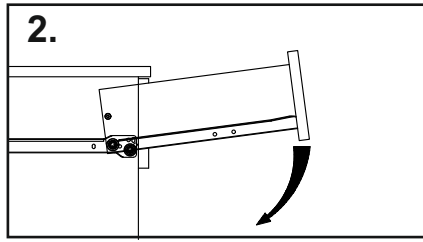
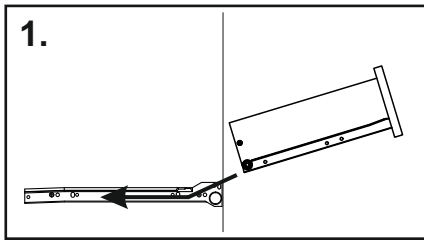
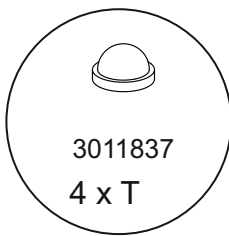
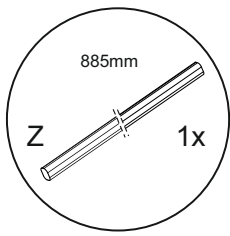
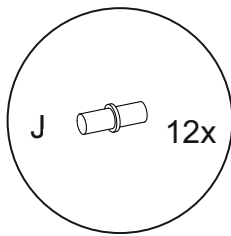

16

3,5 x 16,0mm

F 14x

M 7x

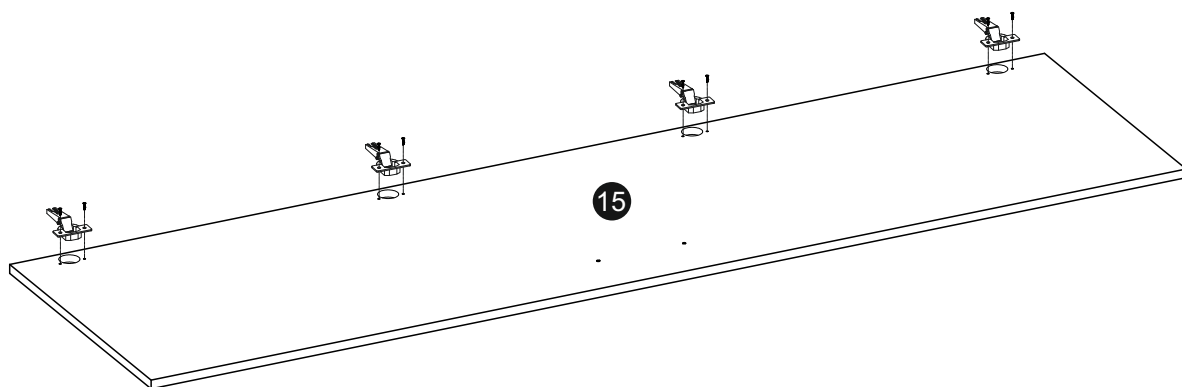
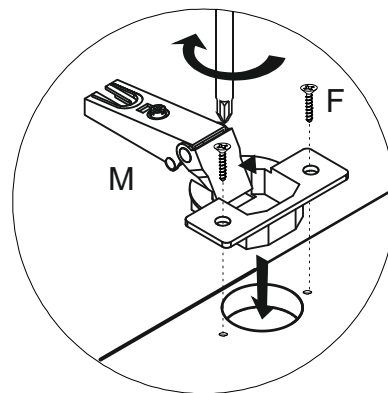
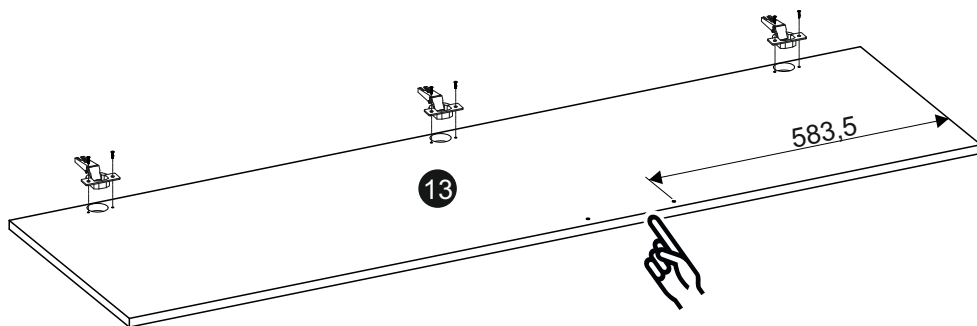

17

3,5 x 16,0mm

F 6x

N 3x

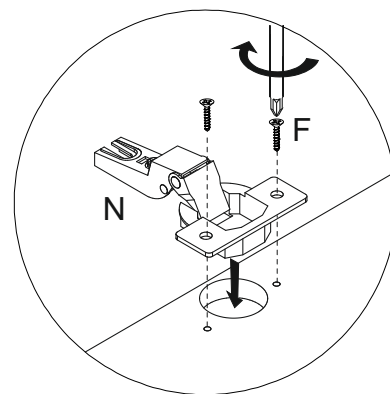
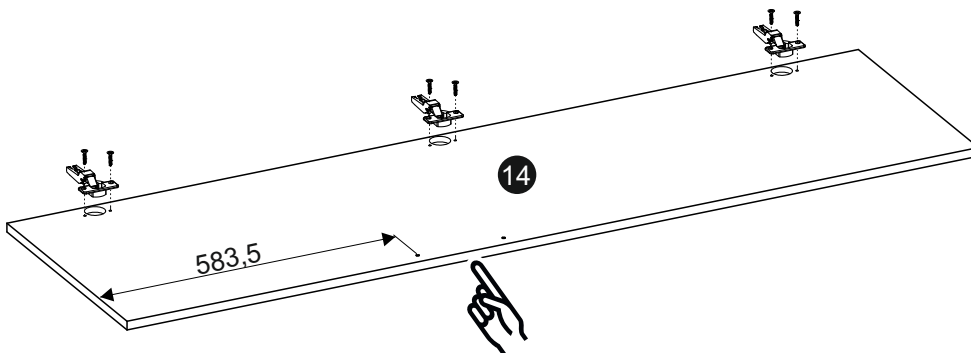

18

